



PRO-VISION
Video Systems

DVR-906M VIDEO RECORDING
SYSTEM GUIDE

provisionusa.com

6/11/2020

Thank you for choosing **PRO-VISION Video Systems!**

IMPORTANT NOTICES

PRO-VISION tries to ensure that the information provided in this document is as comprehensive as possible at the time of publication. However, because of PRO-VISION's drive to provide the best products through continual improvement, PRO-VISION reserves the right to update the information in this document at any time without prior notice.

Copyright © 2020 PRO-VISION Solutions, LLC. All Rights Reserved. This document and supporting data are the exclusive property of PRO-VISION, Inc. and may not be copied, reproduced, or translated to another language without permission.

PRO-VISION provides no warranty of any kind with regard to this material, including, but not limited to, the implied warranties of merchantability and fitness for a particular purpose. PRO-VISION shall not be held liable for errors contained within this document or for incidental or consequential damages in connection with the furnishing, performance, or use of this material.

PRO-VISION®, BODYCAM®, PV Dashboard®, and SecuraMax® are registered trademarks of PRO-VISION Solutions, LLC. All other products or name brands mentioned herein are the property of their respective owners.

SOFTWARE AND FIRMWARE UPDATES

PRO-VISION is committed to the continual testing and improvement of our software and firmware. As new revisions become available, these updates will be made available to your company; fees may apply depending on your licensing agreement.

THIRD-PARTY PRODUCTS

PRO-VISION expressly disclaims all responsibility and liability for the installation, use, performance, maintenance, and support of third-party products. PRO-VISION advised its customers to make independent evaluations of such products.

SUGGESTIONS

PRO-VISION prides itself on designing its products with the customer in mind. We want to hear from you. Tell us about your experience and how you are using your PRO-VISION products. Our team is dedicated to providing the best product experience; we will try our best to accommodate any suggestions provided into our future products and services.

MANUFACTURER CONTACT INFORMATION

PRO-VISION Solutions, LLC.
8625-B Byron Commerce Dr.
Byron Center, MI 49315
800-576-1126
www.provisionusa.com

For more information about PRO-VISION and its products, go to www.provisionusa.com or call us at (800) 576-1126.

INSTALLATION 2

- Installation Quick Guide..... 2
- Product Contents..... 3
- Understanding the System 7
- DVR Installation..... 12
- Analog Camera Installation 14
- Digital HD Camera Installation 24
- Display Installation..... 44
- External Trigger Inputs 46
- Wi-Fi Antenna Installation..... 47
- Event Marker Button Installation 48
- GPS Receiver Antenna Installation 49
- Solid-State Drive (SSD) Installation 50

CONFIGURATION 51

- DVR Status Lights 51
- Connecting to the DVR..... 52
- Setup Wizard 52
- Basic DVR Settings 53
- Advanced DVR Settings 57

OPERATION 62

- DVR Status Lights 62
- Viewing Cameras on a Smart Device..... 63
- Viewing Cameras on a Display..... 63
- View Files on Web..... 64
- Accessing Stored Video Files..... 64

TROUBLESHOOTING..... 65

COMPLIANCE 71

WARRANTY 71

Please read this manual carefully before use and keep it for future reference.

Understanding this manual prior to installation will greatly reduce the time needed for system installation.

Technical support is available Monday thru Friday from 8:00 AM to 5:00 PM EST for questions.





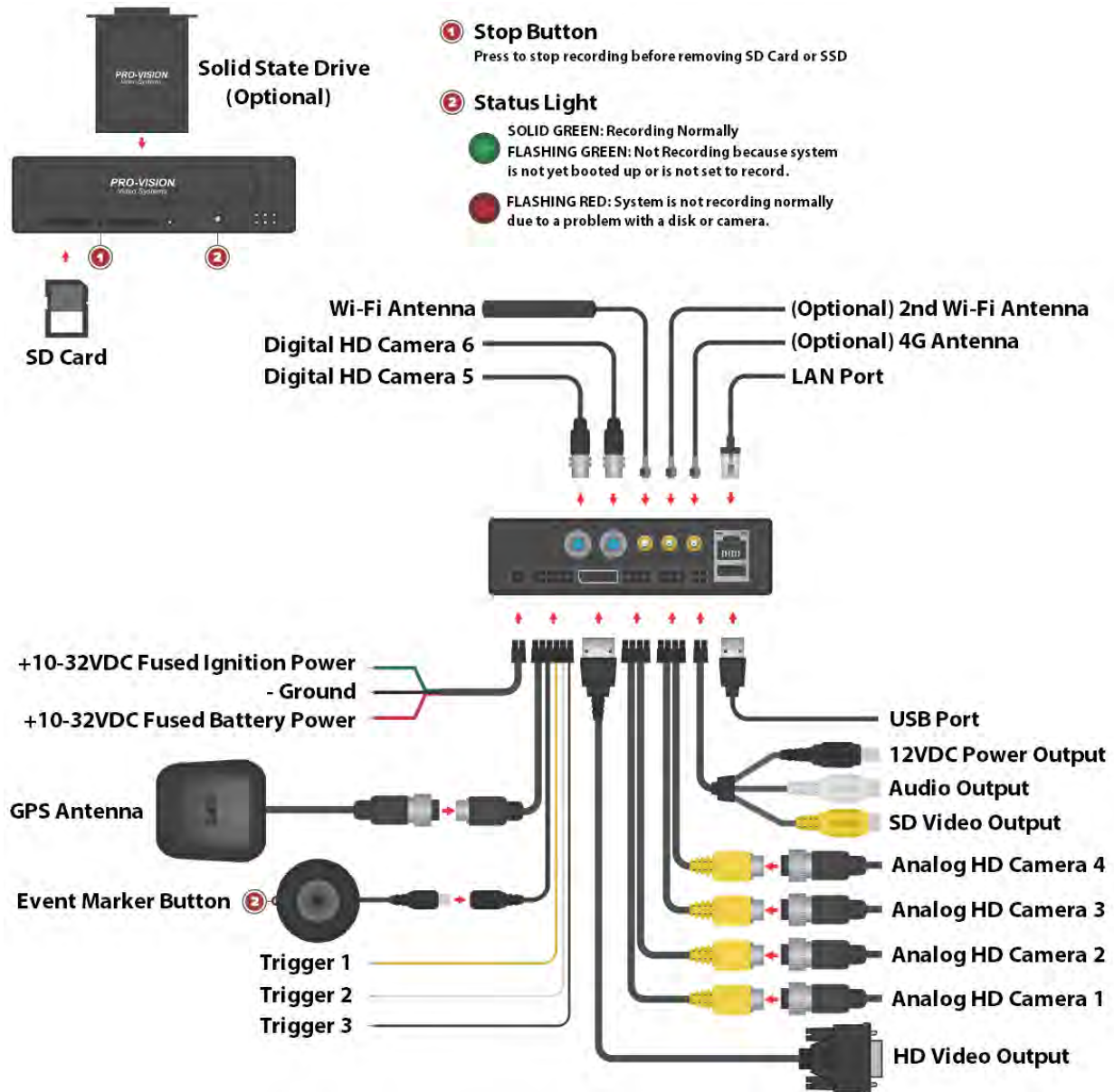













Installation Quick Guide

This page is designed for quick reference. Continue further in this guide for detailed instructions.











Product Contents
Systems







DVR-906M1, M2, M3, and M4 Hybrid HD Recording Systems

Photo	Qty	Part #	Item / Assembly Description
	1	PD-1900	Solid-State Hybrid 1080p HD DVR
	1	PD-1808	Locking Enclosure Base
	1	PD-1809	Locking Enclosure Cover
	1	PD-1718 *	64GB SDXC Card * [DVR-906M-64 Only]
	1	PD-1728 *	128GB SDXC Card * [DVR-906M-128 Only]
	1	PD-1738 *	256GB SDXC Card * [DVR-906M-256 Only]
	1	PD-1798	Two (2) Keys for Locking Enclosure
	1	PD-1771	Power Cable with Two (2) Inline Fuse Holders
	1	PD-1772	Camera 1 / Camera 2 Interface Cable
	1	PD-1773	Camera 3 / Camera 4 Interface Cable
	1	PD-1774	Standard Definition A/V Output Cable
	1	PD-1833	GPS / Event Marker / Trigger Cable
	1	PC-1921*	AHD Mini-Dome Camera with Microphone and Mounting Hardware * (Qty 1 for M1, 2, for M2, 3 for M3, 4 for M4)
	1	PX-1843*	33ft AHD A/V Cable * (Qty 1 for M1, 2, for M2, 3 for M3, 4 for M4)
	2	PX-1814	Hardware Kit with Two (2) Self-Tapping Sheet Metal Screws
	2	PD-1924	Wi-Fi Antenna
	1	DVR-750	GPS Antenna with Mounting Adhesive
	1	DVR-710	Event Marker Button with Mounting Adhesive
	1	PL-4900	USB Drive with Installation Guides, Instruction Guides, and Playback Software



Digital HD Camera Kit Options

Photo	Part #	Item / Assembly Description
	DVR-810	Digital HD Night-Vision Dome Camera with 20ft Cable and Mounting Hardware
	DVR-813	Digital HD Windshield Camera with 10ft Cable and Mounting Hardware
	DVR-814	Digital HD Waterproof Side Camera with 20ft Cable and Mounting Hardware
	DVR-816	Digital HD Waterproof Exterior Camera with 20ft Cable and Mounting Hardware
	DVR-818	Digital HD Wide Angle Camera with 20ft Cable and Mounting Hardware
	DVR-820	Digital HD Waterproof Wide Angle Exterior Camera with 20ft Cable and Mounting Hardware
	DVR-821	Digital HD Wide Angle Mini-Dome Camera with 20ft Cable and Mounting Hardware
	DVR-824	Digital HD Dual-Lens Stop-Arm Camera with 20ft Cable and Mounting Hardware





Analog HD Camera Kit Options

Photo	Part #	Item / Assembly Description
	DVR-910	AHD 2" Marker Light Camera with 30ft Cable and Mounting Hardware
	DVR-912	AHD Low Profile Camera with 30ft Cable and Mounting Hardware
	DVR-916	AHD Heavy Duty Camera with 30ft Cable and Mounting Hardware
	DVR-918	AHD Flush Mount Camera with 30ft Cable and Mounting Hardware
	DVR-920	AHD Side Camera with 30ft Cable and Mounting Hardware
	DVR-921	AHD Mini-Dome Camera with 30ft Cable and Mounting Hardware











Analog SD Camera Kit Options

Photo	Part #	Item / Assembly Description
	PC-1110W	VLI Series Night Vision Wireless Camera with Receiver, 15ft A/V Cable, and Mounting Hardware
	PC-1220WC	VLI Series Wireless Camera and Mounting Hardware















Display Kit Options & Accessories

Photo	Part #	Item / Assembly Description
	PM-1950S	5" LCD Monitor Kit with Harness, 15ft A/V Cable, DVR Cable, Mounting Bracket, and Hardware
	PM-1930S	5" Waterproof LCD Monitor Kit with Harness, 15ft A/V Cable, DVR Cable, Mounting Bracket, and Hardware
	PM-1970S	7" LCD Monitor Kit with Harness, 15ft A/V Cable, DVR Cable, Mounting Bracket, and Hardware
	PM-1910S	9" Quad View LCD Monitor Kit with Harness, 15ft A/V Cable, DVR Cable, Mounting Bracket, and Hardware

Storage & Readers

Photo	Part #	Item / Assembly Description
	DVR-716	Spare 32GB Class 10 SDHC Card
	DVR-718	Spare 64GB Class 10 SDXC Card
	DVR-728	Spare 128GB Class 10 SDXC Card
	DVR-738	Spare 256GB Class 10 SDXC Card
	DVR-102	SDXC Card Reader
	DVR-830	500GB Solid-State Drive
	DVR-831	1TB Solid-State Drive
	DVR-832	2TB Solid-State Drive
	DVR-834	4TB Solid-State Drive
	DVR-802	Solid-State Drive Reader

Cables & Related Accessories

Photo	Part #	Item / Assembly Description
	PX-1942	Analog 15ft A/V Cable
	PX-1943	Analog 33ft A/V Cable
	PX-1841	Digital 10ft HD A/V Cable
	PX-1842	Digital 20ft HD A/V Cable
	PX-1843	Digital 30ft HD A/V Extension Cable
	PX-1848	Digital HD Camera Expansion Cable
	PD-1456	Analog Video Splitter Cable
	PX-1072	Analog Two Camera Control Device
	PX-1016	Analog Trailer Connection Kit
	PX-1016A	Analog Truck Receiver Kit with 33ft Analog A/V Cable and Mounting Hardware
	PX-1016B	Analog Trailer Receiver Kit with 33ft Analog A/V Cable and Mounting Hardware
	PD-1771	Power Cable with Two (2) Inline Fuse Holders
	PD-1975	Hybrid HD Video Output Cable
	PD-1977	Hybrid HD Cable Pack with Cam1/2 Cable, Cam3/4 Cable, A/V Output Cable, and GPS/EVT/Triggers Cable
	DVR-928	Hybrid HD Wireless Automatic File Transfer Kit
	PX-1030	Ultrasonic Sensor Kit with Four (4) Sensors and Mounting Hardware
	PX-1220W	Analog Wireless Transmitter & Receiver with Mounting Hardware
	PX-1220WR	Analog Wireless Receiver with Mounting Hardware
	PX-1220WT	Analog Wireless Transmitter with Mounting Hardware
	DVR-710	Event Marker Button with Mounting Adhesive
	DVR-750	GPS Antenna with Mounting Adhesive
	PD-1798	Two (2) Spare Keys for Lockable Enclosure
	PL-4900	USB Drive with Installation Guides, Instruction Guides, and Playback Software

Understanding the System

PD-1900 DVR Unit:

The Digital Video Recorder (DVR) unit is located inside the locking cage. To remove the DVR, slide the top of the cage forward slightly and lift up on the front. The DVR is removed by lifting on the front of the DVR and sliding it forward.



This device complies with Part 15 of the FCC Rules. Operation is subject to the following two conditions: (1) this device may not cause harmful interference, and (2) this device must accept any interference received, including interference that may cause undesired operation.



Front of DVR:

- 1 – SDXC Card Slot
- 2 – Record STOP Button
- 3 – 4G Status Indicator
- 4 – 4G SIM Card Slot
- 5 – Solid-State Drive Tray
- 6 – System Status Indicator
- 7 – Operational Status Indicators

Rear of DVR:

- 1 – Power Cable Connection
- 2 – GPS/EVT/Triggers Cable
- 3 – HD A/V Output Connection
- 4 – Analog Camera Input Connections
- 5 – A/V Output Connection
- 6 – USB Port
- 7 – LAN Port
- 8 – Wi-Fi Antenna Connections
- 9 – 4G Antenna Connection
- 10 – Digital HD Camera Inputs

Locking Cage:

PD-1808 Locking Cage Base:

The locking cage base is used to secure the DVR in whichever mounting position the user requires. It can be mounted flat, on the side or inverted.



PD-1809 Locking Cage Cover:

The locking cage cover completes the DVR cage and allows the user to lock and secure the DVR from being tampered with.



Data Storage Devices & Readers

SD Card:

The base DVR-906M kit may come with different size SD cards base on the ending of the kit number. Kits ending in “-64” includes a 64GB SDXC card. The SD card is the primary recording media for your DVR unit; it contains the video that is recorded by the DVR.

Spare/Replacement cards are available in various sizes to meet the desired storage capacity requirements:

- 32GB SDHC (P/N: PD-1716)
- 64GB SDXC (P/N: PD-1718)
- 128GB SDXC (P/N: PD-1728)
- 256GB SDXC (P/N: PD-1738)

IMPORTANT: *The SD card can only be inserted into the unit with the contacts first and label facing away from the windshield. If the SD card is inserted improperly, you risk damage that may not be covered under warranty.*

Normal:

Switch must be in this position to record.

Read-Only:

Slide the switch down to protect video from accidentally being erased.

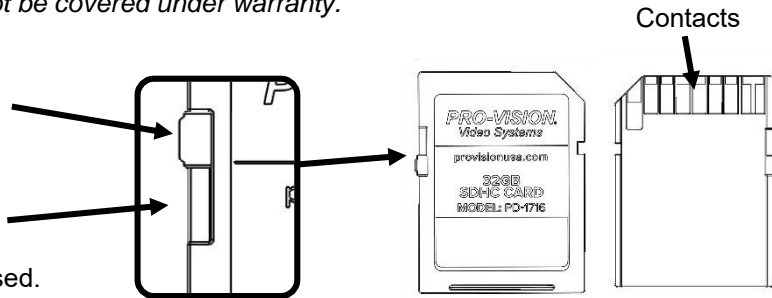

USB Card Reader

The USB Card Reader (P/N: DVR-102) allows any SD, SDHC, or SDXC card to be read in a computer through a USB port. For best performance use a USB2.0 port; this will provide the maximum read speed from the SD card.



Solid-State Drive:

A Solid-State Drive (SSD) is a high-capacity storage device that utilizes high-performance, solid-state flash memory to provide storage that is not affected by the typical vibration experienced in a mobile environment.

Solid State Drives are available in multiple capacities:

- 500GB SSD (P/N: DVR-830)
- 1TB SSD (P/N: DVR-831)
- 2TB SSD (P/N: DVR-832)
- 4TB SSD (P/N: DVR-834)



Solid-State Drive Reader:

The Solid-State Drive Reader (P/N: DVR-802) is a cable used to connect an SSD to a computer for the purpose of viewing files or downloading data from the SSD to a computer or network.



DVR Interface Cables

The DVR Interface Cables are used to connect to the vehicle and other system components.

PD-1771 Power Cable:

This cable supplies battery power to the DVR unit; it also includes an ignition signal input cable to turn the system ON and OFF. The power cable includes fuses for both the battery and ignition power.



PD-1772 Camera 1 / Camera 2 Input Cable:

This cable is used to connect analog cameras 1 and 2 to the DVR unit. It supplies power and receives the video and audio from each camera.



PD-1773 Camera 3 / Camera 4 Input Cable:

This cable is used to connect analog cameras 3 and 4 to the DVR unit. It supplies power and receives the video and audio from each camera.



PD-1774 Video Output Cable:

This cable is used to output the live video and audio from the DVR unit to a display monitor for aiming the cameras or real-time observation of the camera view(s). It includes a temporary power output to power a display for aiming purposes.



PD-1833 GPS/Event/Trigger Cable:

This cable is used to connect the GPS Antenna, Event Marker, and up to three (3) external trigger inputs to the DVR unit.



PD-1924 Wi-Fi Antenna:

Two (2) Wi-Fi Antenna(s) are used by the DVR to allow wireless viewing of the camera and DVR settings as well as wireless transfer of files to a server in a building. At least one antenna needs to be connected to the DVR.



Note: Two (2) antennas will increase the transfer speed, but does not increase the Wi-Fi range.

PX-1842 15ft Analog HD A/V Cable:

15ft Analog HD cables are used for the connecting both analog standard definition (SD) and high definition (HD) cameras to the DVR unit. The male ends connect to cameras and the female ends connect to the DVR.



PX-1843 33ft Analog HD A/V Cable:

33ft Analog HD cables are used for the connecting both analog standard definition (SD) and high definition (HD) cameras to the DVR unit. The male ends connect to cameras and the female ends connect to the DVR.



PX-1841 10ft Digital HD A/V Cable:

10ft Digital HD cables are used for the connecting digital HD cameras to the DVR unit. The male ends connect to cameras and the female ends connect to the DVR.

Note: Two 10-ft. cables cannot be connected to each other. If more than one cable is needed, the PX-1843 30ft Digital HD Extension Cable must be used.

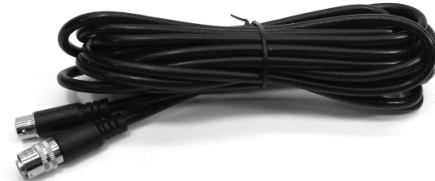

PX-1842 20ft Digital HD Cable:

20ft Digital HD cables are used for the connecting digital HD cameras to the DVR unit. The male ends connect to cameras and the female ends connect to the DVR.

Note: Two 20ft cables cannot be connected to each other. If more than one cable is needed, the PX-1843 30ft Digital HD Extension Cable must be used.

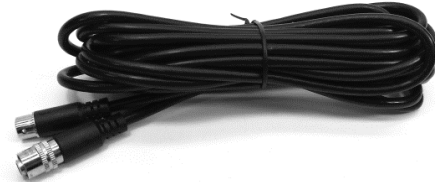

PX-1843 30ft Digital HD Extension Cable:

30ft Digital HD cables are used for the connecting digital HD cameras to the DVR unit. The male ends connect to cameras and the female ends connect to the DVR. The 30ft cable may be used by itself or with any other Digital HD cable, but the 30ft cable must be closest to the DVR. Up to three (3) PX-1843 extension cables may be connected in series.



PX-1848 HD Camera Expansion Cable

The PX-1848 cable can be used on the Digital Camera 5 and 6 inputs of the DVR unit to allow the connection of a 7th and 8th camera. The cable splits the camera input into two (2) inputs; the first is the original input, and the second is the original input number plus two (2). It can be used to make the split at either the DVR location or at the end of one of the standard cables. Only one (1) cable can be used per digital input on the DVR.



DVR Installation

DVR Unit Mounting

The DVR unit is the core of the Recording System. All system connections go to the DVR unit and the storage device (SD Card or SSD) is located inside the DVR unit. It is important to choose a good mounting location for the DVR unit as its location should be readily accessible for viewing status/removing the disk as well as optimal for reducing the installation time of the entire system.

Choosing Mounting Location:

The DVR unit itself is small and can be mounted in a variety of locations. The black lockable mounting cage has four (4) pre-drilled holes for mounting; however additional holes can be drilled in the mounting cage to provide better attachment to the mounting surface.

Things to consider when choosing mounting location:

- Access to the front of the DVR to view lights and/or remove storage media
- Access to insert and turn key to remove cover, test for accessibility if necessary.
- Access to the rear of the DVR for service
- Locate all structural members that may make it difficult to run wires. Avoiding these by choosing a good mounting location saves installation time
- Proximity to other RF devices such as two way radios and computers (must be at least 6" away)
- Cable routing for power, GPS, Event Marker Button, triggers, and cameras
- Fastening to mounting surface and what is behind it

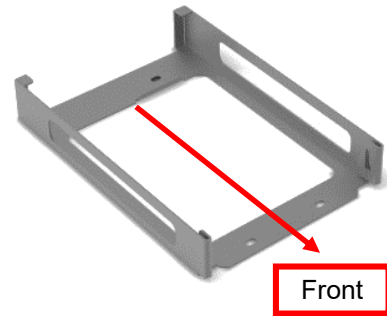

Recommended Mounting Locations:

- Front overhead compartment above windshield: Mount to the driver's side for easy cable routing.
- Compartment above the driver: Place locking enclosure and use the key to ensure easy access.
- Under the first seat behind the driver: Mount inverted directly to the seat bottom.



Example of an International bus in the compartment above the driver

Installing DVR Power Cable

The power cable is an essential component of the DVR unit, it provides power to unit and also controls when the unit turns on and off. It is important to ensure that primary battery power connection is to a clean 12V-24V DC power connection.

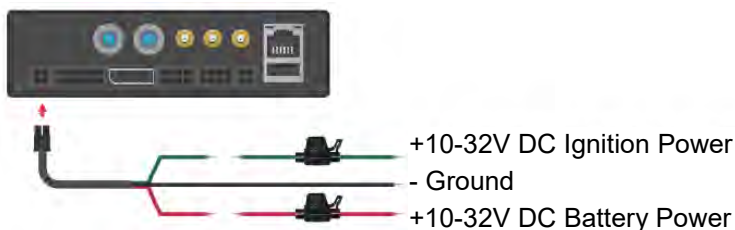

	<p>RED Fused 12-24V DC Battery Power: The battery power wire should be connected to an always-on power location on the vehicle. The connection should include a 3A fuse (provided) and should be connected to its own circuit that is not shared with other components or accessories. If possible, connect directly through a 3A fuse to the positive terminal of the vehicle’s battery.</p>
	<p>GREEN Key ON Ignition Signal: This wire is used to tell the unit when the ignition of the vehicle is ON. It can be connected to a 12/24V DC ignition source through a 3A fuse (provided) or to a ground level ignition source. If using a ground level ignition source, the wire must first be connected to a 12V source, then the setting for “Ignition Level” must be changed in the power menu to the proper “LOW” level setting before final connection to the ground level source.</p>
	<p>BLACK Chassis or Battery Ground: The ground wire should be connected directly to a clean grounding stud/screw or directly to the negative terminal of the battery.</p>

IMPORTANT! Do not connect the red battery power wire to a battery drain protection device such as a ChargeGuard®; this can cause abnormal performance and/or damage the electronics inside the recording unit. The unit itself has a battery drain protection function built in.

IMPORTANT! You must use fuses that can handle the current draw of the unit with all cameras and accessories. With the DVR unit, 8 cameras, GPS, Event Marker Button, and a Solid State Disk (SSD) the current draw is ~3A at 12 VDC.

IMPORTANT! The included red and green fuse holders are for the protection of the DVR unit; it is not required to use these fuse holders if a suitable substitute is provided. Failure to install a fuse inline on the red battery power or green ignition power connection wires could result in damage to the vehicle or system that is not covered under warranty.

Analog Camera Installation

The DVR unit supports any combination on up to four (4) analog Standard Definition (SD) and Analog High Definition (AHD) cameras.

Cameras are connected to the yellow analog camera inputs on the PD-1772 and PD-1773 interface cables (shown below).

Analog HD Camera Cables/Connections:

Cameras can be either directly connected, or connected through analog A/V cables:

- PX-1942 5m (16ft) Analog A/V Cable
- PX-1943 10m (33ft) Analog A/V Cable



Step 1 Align arrows on connectors and then slide them together



Step 2 Thread the collar of the female connector until it is tight



Step 3 Slide the rubber boot over the connectors, completely covering the connection for a durable waterproof seal

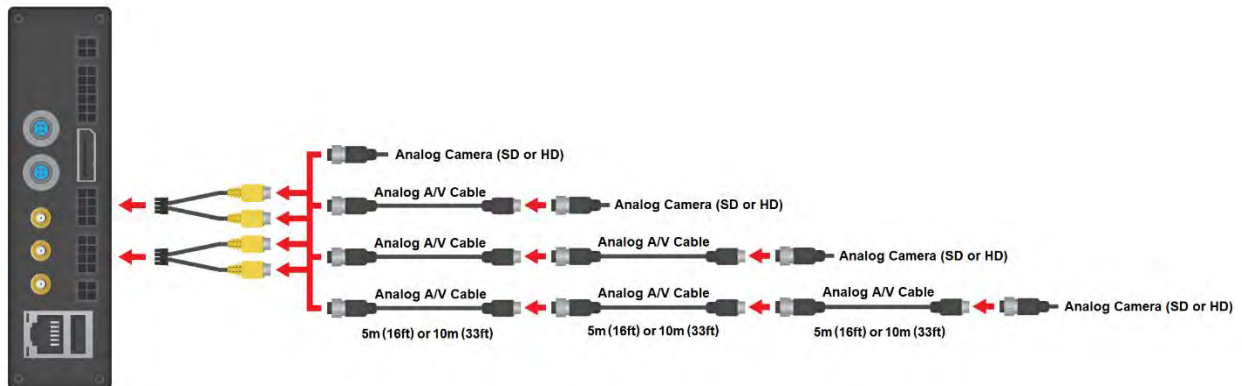

Analog HD Mini-Dome Camera Installation



The AHD Mini-Dome Camera (Kit P/N: DVR-921, Camera P/N: PC-1921) is designed to be mounted inside a vehicle. The camera is used most often inside the passenger seating areas inside buses and trains, but it also works well in the cargo area of box trucks and vans. It has a built-in microphone for audio recording as well as built-in night vision LED's with an automatic sensor for capturing video in low-light conditions. Its small form factor and high adjustability allow this camera to be mounted in a multitude of interior locations. The camera lens has a wide 170° horizontal and 90° vertical coverage.

Mounting Location:

The ball and socket dome design allows 360° rotation around the base, 180° adjustment perpendicular to the base, and 360° rotation to level the image. The camera typically is installed with the cable going through a panel directly underneath the mounting location to hide the cable, but it can also be installed where the cable exits the side of the base if there is no room to route the cable behind the camera's mounting location.

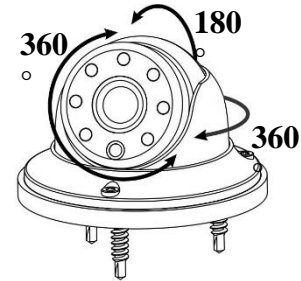

Installation:

1. Disassemble the camera by loosening the three (3) hex head set screws located on the locking ring. Lift up on the locking cover and remove it from the camera assembly. Remove the camera ball and pull the cable through the mounting base.
2. Find the desired camera mounting location and hold the mounting base up in position.
3. Mark the four (4) mounting holes using a marker or pencil.
4. If the cable is going to be routed through the center cable hole and into a panel, mark the center cable hole as well.
5. If applicable, drill out the marked center hole using a 3/4" drill bit. Clean up any sharp edges to prevent damage to the cable.
6. If the camera cable will exit through the cable groove in the mounting base instead of through the mounting surface, the cable must be routed through the cable groove before attaching the mounting the base to the mounting surface.
7. Align the camera base over the marked screw holes and then using a drill with a Phillips bit, install the four (4) self-tapping mounting screws.
8. Connect the camera connector to the cable running to the DVR unit, if it is not yet installed, install the cable at this time and then continue to step 9.
9. Hold the camera ball and feed any excess cable through the hole or cable groove in the mounted base until the camera ball is resting on the center of the mounting base.

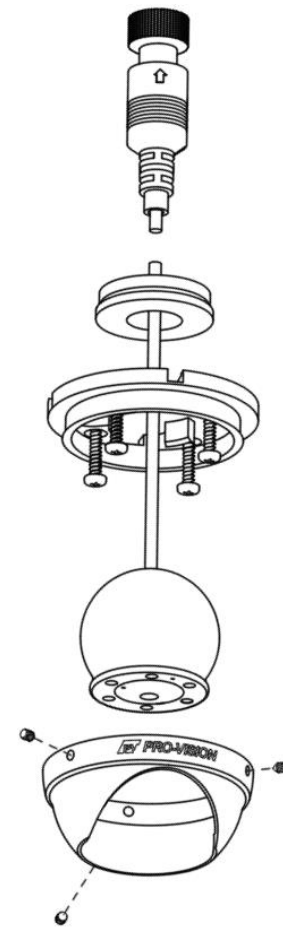

10. Place the camera locking cover over the camera ball. Loosely tighten the three (3) set screws holes using a 1.5mm Allen wrench, allowing the camera ball to freely move until the desired camera aim is set.
11. Power on the DVR unit and connect to the Wi-Fi to view the live camera image to properly aim it on the view page. (See [Viewing Cameras on a Smart Device](#) for connection details)
12. When finished aiming, fully tighten the three (3) set screws.



Example view of the cargo area of a Dodge Ram Cargo Minivan

Analog HD Side Camera Installation



The AHD Side Camera (Kit P/N: DVR-920, Camera P/N: PC-1920) is designed to provide coverage around the outside of the vehicle. The camera is waterproof rated IP-67 and has a wide-angle lens that can capture a wide area around the outside of the vehicle. The camera is designed to be mounted directly to a vehicle exterior body panel. The camera has six (6) infrared (IR) LED's that provide illumination during low light/dark conditions. The camera also has a waterproof microphone built into the camera housing. The camera lens has a wide 145° horizontal and 80° vertical coverage.

Mounting Locations:

The camera's wide field-of-view allow flexible mounting in either a down facing or rear facing configuration while still providing very good coverage of the side of the vehicle. For down facing general recording applications, the camera is typically mounted directly to the roof or side of vehicle body near the roof facing outward perpendicular to the direction of vehicle travel at a downward angle. The camera should be mounted as close to the outside edge of the roofline as possible to prevent blind spots directly next to the vehicle. For rear facing applications utilizing the camera to cover blind spots in combination with a monitor, the camera should be mounted as far toward the front of the vehicle as possible. When mounting to the vehicle, consider spray and debris from the tires could affect the camera image, so it is recommended to mount the camera a minimum of 3 feet off the ground to help prevent this. Always check the mounting structure under the camera for proper access to route the cable.

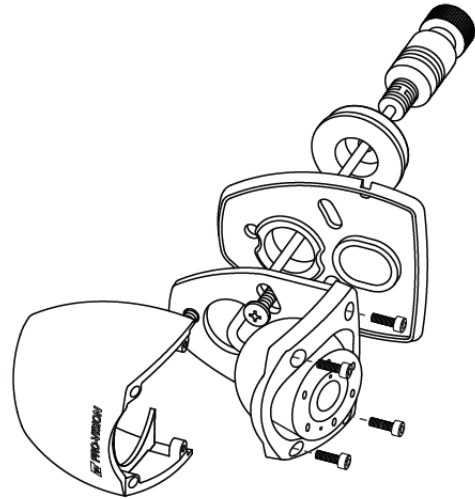

Installation:

1. Remove the four (4) Allen head cover mounting screws from the camera and then remove the camera ball and cable.
2. With just the camera base and gasket, hold in desired mounting location and mark the three (3) camera base mounting screw locations and the center of the cable exit hole in the base.
3. It is recommended to power on the DVR unit, temporarily connect the camera to it, set the camera in the mounting base (with gasket attached), and observe that the view in the desired mounting location is satisfactory before permanently attaching the camera and routing the cable(s).
4. Before drilling holes, ensure there is adequate clearance for mounting screws and cable routing clearance.
5. If you are certain of the cameras mounting location, drill the center cable hole with a 3/4" or 7/8" drill bit, and it is also recommended to predrill the three (3) mounting screw holes with an 1/8" drill bit.
6. Route the camera cable through the base and gasket, and then through the cable hole in the mounting surface.
7. Use the mounting hardware provided to attach the camera base to the mounting location.

8. Attach the camera cover to the camera with the four (4) Allen head mounting screws. Leave the screws slightly loose until the camera is aimed.
9. Power on the DVR unit and connect to the Wi-Fi to view the live camera image to properly aim it on the view page. (See [Viewing Cameras on a Smart Device](#) for connection details)
10. After the camera is aimed, tighten the four (4) Allen head mounting screws to lock the camera aim.



Example view of downward facing application on the driver's side of delivery van

Analog HD Flush Mount Camera Installation



The AHD Flush Mount Camera (Kit P/N: DVR-918, Camera P/N: PC-1918) is designed to be mounted in a body panel or bumper of the vehicle, flush with the surface. The camera is used most often inside the rear bumper of vehicles, but it also works well mounted in an enclosure above the engine compartment or rear window on rear engine busses. It has a built-in night vision LED's with an automatic sensor for capturing video in low-light conditions. Its small form factor and low profile mounting are its biggest advantage. The camera lens has a wide 130° horizontal and 65° vertical coverage.

Mounting Location:

The camera mounts in a 1.25" hole, and can be rotated 360° for proper aim; the camera can also be tilted at a 10° angle by installing the angle rings on either side of the mounting surface.



Installation:

1. Locate the desired mounting location, check for proper clearance behind the surface for the camera body, then mark and drill a 1.25" hole.
2. Disassemble the camera by loosening the two (2) threaded lock rings, removing them, and sliding them off the cable and connector. Then removing all the spacer rings.
3. Determine the order of the spacers as needed based on the desired mounting as shown in the images above right.
4. Slide the outer spacers over the cable and onto the camera, then slide the camera, cable first, through the mounting hole.
5. Slide the inner spacers over the cable and onto the camera.
6. Install the mounting gasket between the outer mounting surface and the camera body or the first spacer.
7. Slide the two (2) threaded locking rings over the cable and then thread them one at a time onto the camera body.
8. Connect the camera connector to the cable running to the DVR unit, if it is not yet installed, install the cable at this time and then continue to step 9.
9. Power on the DVR unit and connect to the Wi-Fi to view the live camera image to properly aim it on the view page. (See [Viewing Cameras on a Smart Device](#) for connection details)
10. When finished aiming, fully tighten the first locking ring and then the second locking ring.

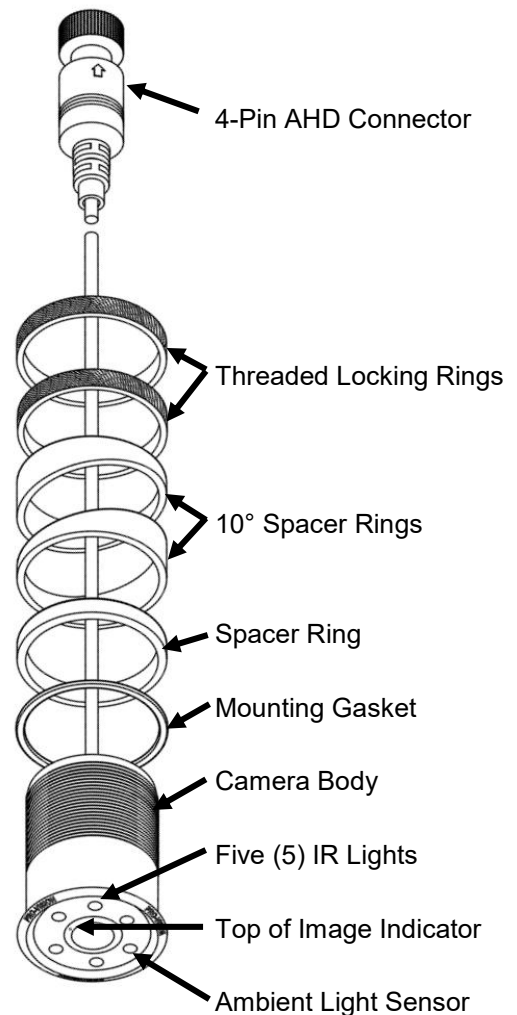

Analog HD Marker Light Camera Installation



The AHD Flush Mount Camera (Kit P/N: DVR-910, Camera P/N: PC-1910) is designed to be mounted in an existing 2" marker light hole in the rear body of the vehicle to replace a standard 2" marker light. The camera is used most often as a backup camera and replaces a marker light in the rear bumper. This camera is primarily used because it does not require any holes to be drilled in the vehicle body and is typically very durable because the marker lights are typically mounted in a protected area on the rear of the vehicle. The camera lens has a wide 145° horizontal and 80° vertical coverage.

Mounting Location:

The camera mounts in an existing 2" marker light hole. The camera can be rotated 360° for proper aim, but cannot be tilted at an angle. If possible, the camera should replace the center most marker light to provide the driver with the most natural view.

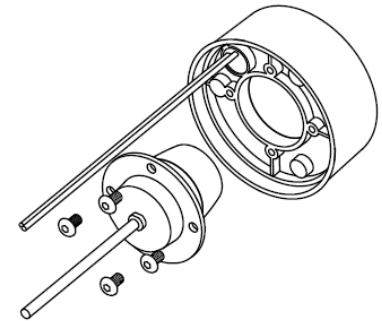

Installation:

1. Locate the desired mounting location, remove the existing light to check for proper clearance for the camera body.
2. Disconnect the wiring from the original light, then remove it and the grommet.
3. Assemble the camera to the light assembly using the 4 mounting screws.
4. Install the new grommet into the hole.
5. Connect the red 12V LED power wire and black ground wire from the light assembly to the existing wiring through the grommet.
6. Slide the camera cable into the hole in the back of the grommet.
7. Connect the camera connector to the cable running to the DVR unit, if it is not yet installed, install the cable at this time.
8. Press the camera light assembly into the grommet and rotate the camera until the white dot is at the top.
9. Power on the DVR unit and connect to the Wi-Fi to view the live camera image so it can be properly adjusted to level by rotating the light in the grommet. (See [Viewing Cameras on a Smart Device](#) for connection details)

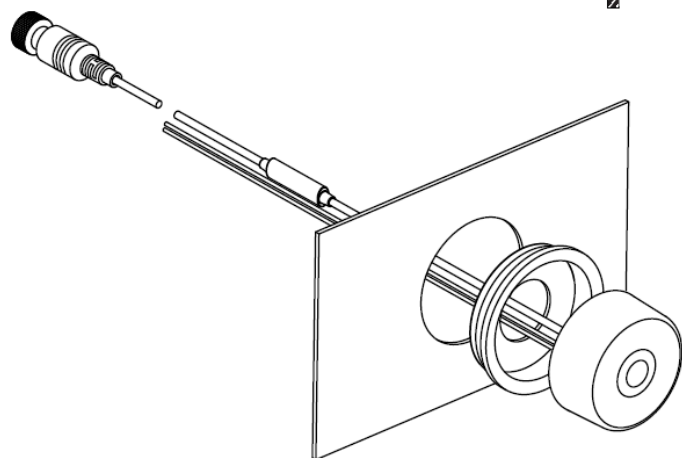
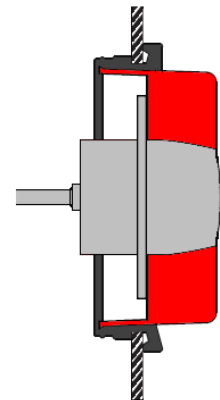

Analog HD Low Profile Camera Installation



The AHD Low Profile Camera (Kit P/N: DVR-912, Camera P/N: PC-1912) is designed to be mounted in the rear of the vehicle. It is very low profile, allowing it to be mounted at the top of the rear for easier wiring and better field of view. The camera mounting hole pattern matches that standard 7" on center spacing of

US license plates for easy mounting over license plates for light duty vehicle applications where space is limited or drilling holes is not desired. The camera has four (4) infrared (IR) LED's that provide illumination during low light/dark conditions. The camera also has a waterproof microphone built into the camera housing. The camera lens has a wide 145° horizontal and 80° vertical coverage.

Installation:

1. Locate the desired mounting location of the camera. It is recommended to power on the DVR unit and temporarily connect the camera to it and observe that the view in the desired mounting location is satisfactory before proceeding to the next step.
2. When the desired mounting location is found, mark or measure the two (2) mounting screw hole locations in the camera. If license plate mounting, skip this step.
3. If the cable will be routed through the vehicle body, it is common to drill a 3/4" hole behind the camera where the cable exits the camera body, mark and drill this hole if needed. Remove any burrs from the hole to prevent damage to the cable. If license plate mounting, there is a notch in the top left of the camera for the cable to exit and then route into the body of the vehicle.
4. Route the camera cable into the hole and then install the camera to the marked locations from step 2. Attach the camera with the supplied mounting hardware.
5. Route and install the extension cable(s) to the cameras final mounting location and connect it to the camera. Leave enough slack to allow removal of the camera if necessary for service in the future. (Typically 4-6")
6. Power on the DVR unit and connect to the Wi-Fi to view the live camera image to properly aim it on the view page. (See [Viewing Cameras on a Smart Device](#) for connection details) To adjust the camera aim, loosen the two (2) small Phillips head screws on either side of the camera assembly.
7. After the camera is aimed, tighten the two (2) Phillips head adjustment screws.

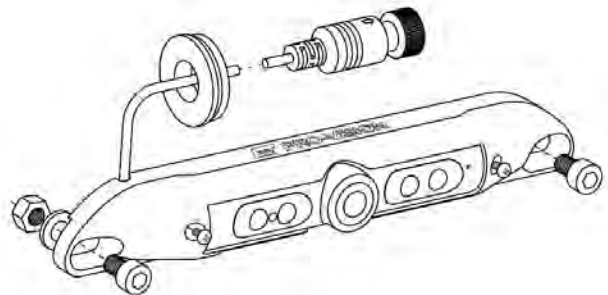

Example view from the rear of a Thomas C2 School Bus

Analog HD Heavy Duty Camera Installation



The AHD Heavy Duty Camera (Kit P/N: DVR-918, Camera P/N: PC-1918) is designed to be mounted in the rear of the vehicle. It is relatively small, allowing it to be mounted at the top of the rear for easier wiring and better field of view. The camera bracket allows for very flexible mounting above, below, or directly to the mounting surface. The camera has four (4) infrared (IR) LED's that provide illumination during low light/dark conditions. The camera also has a waterproof microphone built into the camera housing. The camera lens has a wide 110° horizontal and 60° vertical coverage.

Mounting Location:

This camera is often used on the rear of the bus to provide video capture backup incidents and traffic behind the bus. The camera can only be mounted to a horizontal surface, it can be mounted above, below, or directly to the mounting surface and can adjust up to 180°. The camera mounting screw holes are slotted to allow the camera to be aimed left or right after mounting.



Installation:

8. Locate the desired mounting location of the camera. It is recommended to power on the DVR unit and temporarily connect the camera to it and observe that the view in the desired mounting location is satisfactory before proceeding to the next step.
9. When the desired mounting location is found, mark or measure the two (2) mounting screw hole locations in the bracket (Shown in **ORANGE** at right). If necessary, remove the camera from the bracket.
10. If the cable will be routed through the vehicle body, it is often routed through a 3/4" holed drilled directly in the center of the vehicle body behind the bracket (Shown in **RED** color above). Mark and drill this hole if needed. Remove any burrs from the hole to prevent damage to the cable.

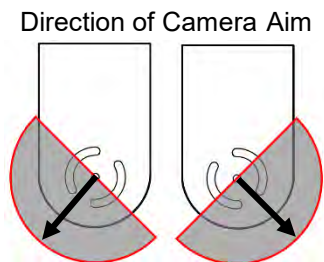
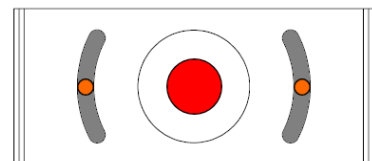

11. Install the camera bracket to the marked locations from step 3 (Shown in **ORANGE** above). Ensure the bracket is oriented for properly aim as shown in the image above right, if needed flip the bracket 180° to allow proper adjustment.
12. Install the camera into the bracket with the six (6) screws, metal washers, and nylon washers as shown at right. Leave the screws slightly loose until final camera aim adjustment is completed.
13. Route the camera cable through the mounting hole in the center of the bracket (if applicable) and install a grommet or put adhesive around the cable to provide a seal with the hole.

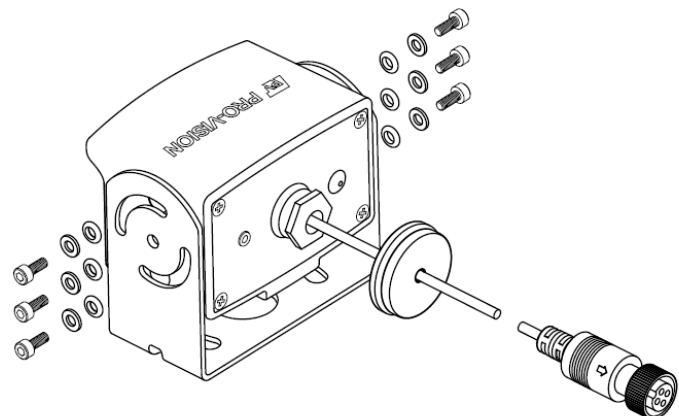

14. Route and install the extension cable(s) to the camera's final mounting location and connect it to the camera. Leave enough slack to allow removal of the camera if necessary for service in the future. (Typically 4-6")
15. Power on the DVR unit and connect to the Wi-Fi to view the live camera image to properly aim it on the view page. (See [Viewing Cameras on a Smart Device](#) for connection details)
16. After the camera is aimed, tighten the six (6) mounting screws on the sides of the camera.



Example view from the rear of a Thomas C2 School Bus

Digital HD Camera Installation

The DVR unit supports two (2) digital HD cameras which can be expanded up to four (4) digital HD cameras by using PX-1848 Expansion Cables.

Digital HD Camera Cables/Connections:

Each of the digital HD cameras can be connected via a single 10 ft. or 20 ft. cable included with the camera kit or using a specific combination of multiple cables (See below).

To connect a camera or cable, align the arrow on the connector with the notch on the plug on the DVR unit (arrow should be visible when looking at the DVR unit from the top) and then gently press the connector in holding on to the black part of the connector until a click is heard. The HD cameras and cables use a sliding quick release collar on the female connectors, holding this connector by the sliding metal collar will make it difficult for the release mechanism to engage when connecting the camera or cable.

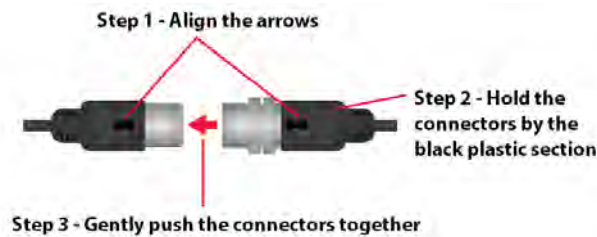

To disconnect a camera or cable, simply grab the female connector by the metal collar and pull it backwards to disengage the locking mechanism and allow the connectors to separate.



Up to two (2) Digital HD cameras can be connected to the DVR using the configurations shown below:

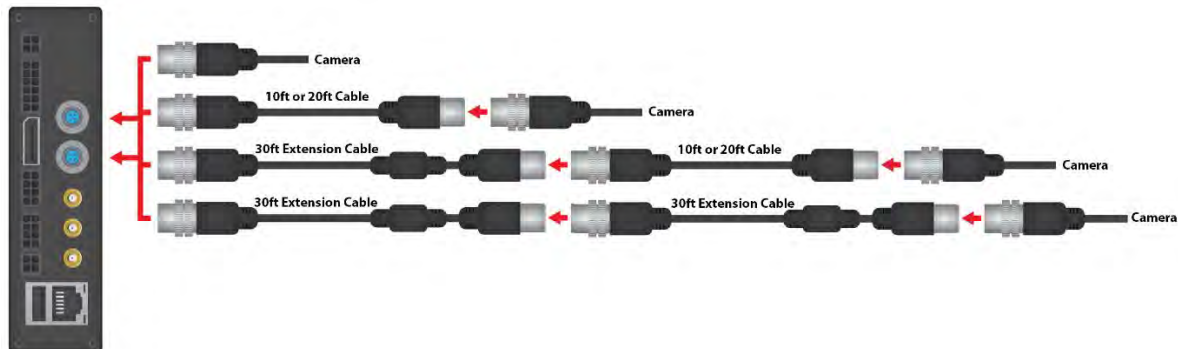

IMPORTANT! If you are using a 30 ft. Extension Cable (Part # PX-1843) it must be connected directly to the DVR Unit or to another 30 ft. Extension Cable in the proper order as shown above. Connecting two 10 ft. / 20 ft. Cable together or between the 30 ft. Extension Cable and the DVR will provide intermittent or no camera signal.

Cable Routing:

After the locations of DVR and cameras have been determined, cables for the camera(s) can be routed. Determine the approximate cable routing to the locations of each of the cameras. Remove all panels along the route that cables will take to ensure accessibility. After the panels are removed and the path is accessible install the cables.

Installation Tips:

1. For multi-camera installations it is recommended to mark both ends of the camera cable with the camera number using a marker with text (1, 2, 3, 4, etc.) or tick marks (I, II, III, IIII, etc.) on both ends of each cable. This will easily identify which cable is at each location when final connections are made to the DVR.
2. Carefully open all video cables and lay them out to full length. This will make it easy to pull the cable and make sure there are not snags or knots in the cable while it is unraveling.
3. When making holes for cables in panels drill a 3/4" hole with a drill bit or step drill bit.
4. Leave at least 4" of slack near the camera connection points to allow future servicing of cameras.
5. If excess cable is present, this can be doubled over or wound up. After all cables are run, you may wish to use cable ties to hold them in place. If you do this, do not overtighten the cable ties. It is possible to damage the shielding inside the cables by overtightening; make the cable ties snug or slightly loose. Do not use a cable tie guns as these will overtighten the cable ties.

IMPORTANT! Read and understand the installation instructions below for the camera(s) to be installed **BEFORE** drilling any holes in the vehicle. Some of the cameras have specialized mounting designs that are not apparent without reading the instructions.

Digital HD Camera Expansion Cable

The Digital HD Expansion Cable (P/N: PX-1848) can be used on the Digital Camera 5 and 6 inputs of the DVR unit to allow the connection of a 7th and 8th camera. The cable splits the camera input into two (2) inputs; the first is the original input, and the second is the original input number plus two (2). It can be used to make the split at either the DVR location or at the end of one of the standard cables. Only one (1) cable can be used per digital input on the DVR.

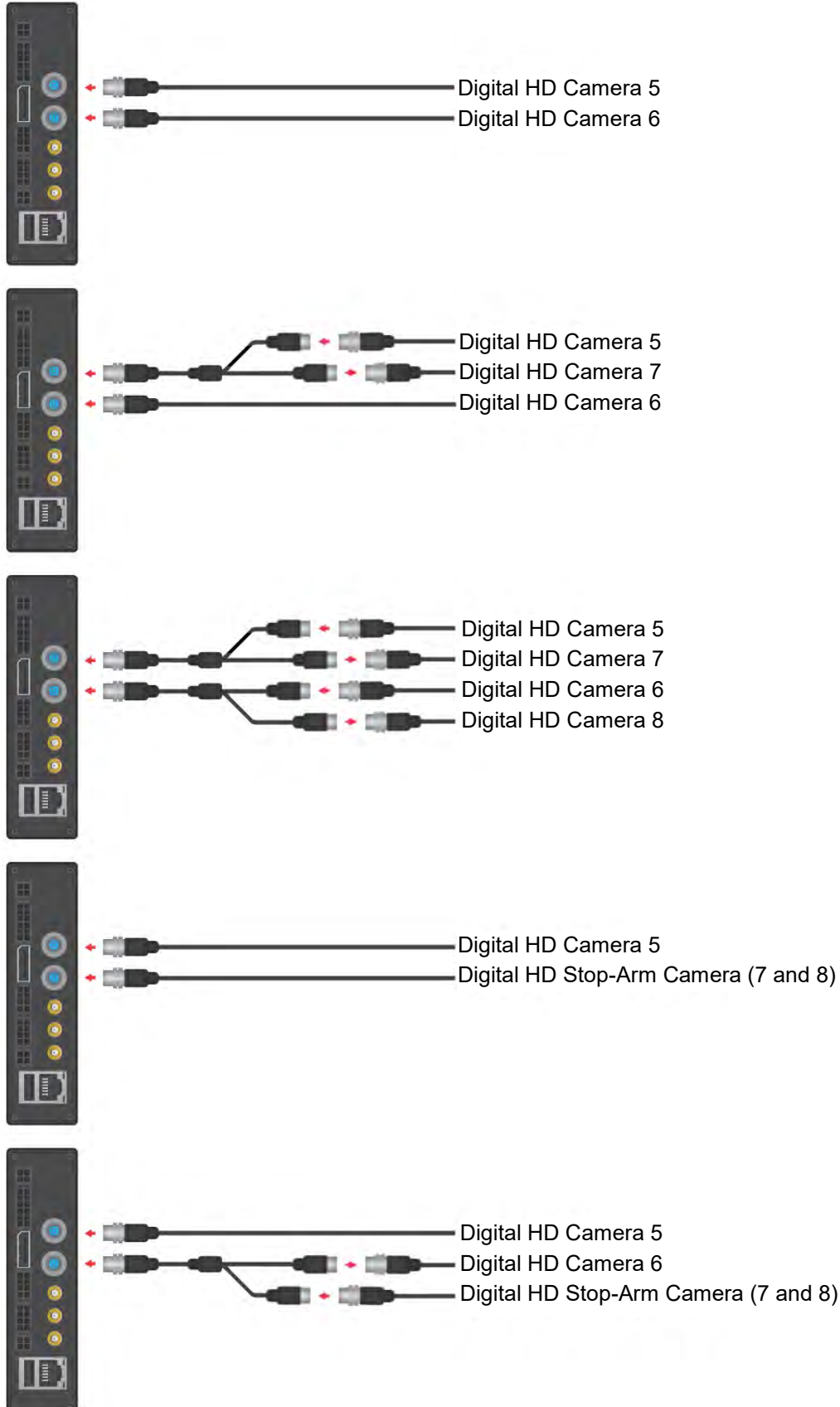

Digital HD Dome Camera Installation



The Night Vision Dome Camera (Kit P/N: DVR-810, Camera P/N: PC-1810) is a versatile camera for use inside a vehicle. It is not waterproof and cannot be mounted outside the vehicle. It has a built-in microphone for audio recording as well as built-in night vision LED's with an automatic sensor for capturing video in low-light conditions. The camera is used most often inside large transit vehicles such as buses and trains, but it also works well in the cargo area of box trucks and vans.

Mounting Location:

This camera is very flexible for mounting purposes; it can be mounted in almost any direction and the camera ball adjusted back to a level image. The ball and socket dome design allows 360° rotation around the base, 180° adjustment perpendicular to the base, and 360° rotation to level the image. The camera typically is installed with the cable going through a panel directly underneath the mounting location to hide the cable, but it can also be installed where the cable exits the side of the base if there is no room to route the cable behind the camera's mounting location.

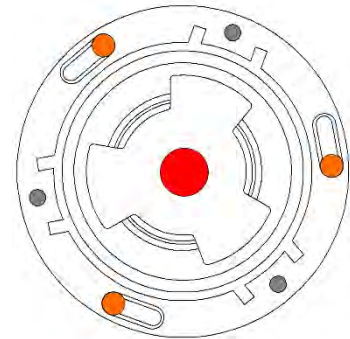

Installation:

1. Disassemble the camera by loosening the three (3) Phillips head screws on the camera housing base. Then separate the bottom base from the camera ball and mounting rings.
2. Find the desired camera mounting location and hold the camera base up in position. Mark the three (3) mounting holes using a marker (Shown in **ORANGE** above right). The camera holes are slotted, only mark the center of the large hole in the slot in each of the three positions.
3. If the camera cable will route through the mounting surface, mark an additional hole at the center of the base (Shown in **RED** above right)
4. If applicable, drill out the marked center hole to 5/8" using a drill bit or step drill bit. Clean up any sharp edges to prevent damage to the cable.
5. Align the camera base over the marked screw holes and then using a cordless drill with Phillips bit, install the three (3) self-tapping mounting screws.
6. If the camera cable will exit the side of the camera in front of the mounting surface, you must loosen the three (3) screws slightly to feed the camera connector between the camera base and the mounting surface. Then align the camera cable into one of the notches in the camera base and carefully tighten the mounting screws of the base.

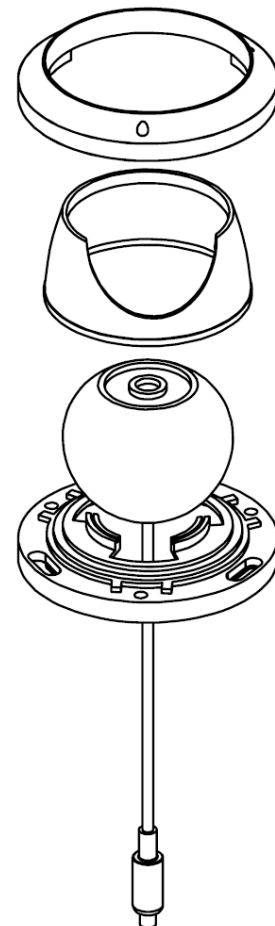

7. Connect the camera connector to the cable running to the DVR unit, if it is not yet installed, install the cable at this time and then continue to step 8.
8. Hold the camera ball onto the base feeding any excess cable back through the hole in the base.
9. Place the mounting rings of the camera over the ball in the same order as removed, ensure that the three (3) mounting screws align with the holes in the base.
10. Using a Phillips screwdriver, tighten each of the three (3) screws; leave the screws slightly loose to allow the camera ball to freely move until the final camera aim is completed.
11. Follow the instructions in [Viewing Cameras on a Smart Device](#) to access the unit and aim the camera. Then tighten the three (3) screws firmly to secure the cameras position.



Example view of the interior of a handicap shuttle bus

Digital HD Windshield Camera Installation



The Wide-Angle Windshield Camera (Kit P/N: DVR-813, Camera P/N: PC-1813) is designed to mount to glass and view through it either out the front or side of the vehicle. This camera has a wide-angle 130° horizontal field-of-view that allows it to cover a wide area directly out the window. The camera has a photocell to switch the camera into low light/night mode as required. A microphone is built into the front of the camera; this microphone can be disabled. There is a red LED on the front of the camera that will flash to indicate the recording status.

Mounting Location:

This camera is designed to be mounted in the front window as close to centered on the vehicle as possible. Commonly the camera location is at the center of the window just below the tint, or just to the passenger side of divided windows. This camera can also be used to look out the fixed side windows of a vehicle.

Installation:

1. Slide the bracket over the top of the camera and attach the four (4) side attachment screws through the holes on each side of the bracket into the camera. Install these screws only finger tight as final adjustments to camera aim will need to be made later.
2. Remove the film from one side of the adhesive pad and apply the pad to the bracket. DO NOT remove the windshield side of the film yet.
3. Clean the windshield in the approximate area of camera mounting.
4. It is recommended to power on the DVR unit and temporarily connect the camera to it and observe that the view in the desired mounting location is satisfactory before permanently attaching the camera and routing the cable(s).
5. When the desired mounting location is found, mark bracket location with tape.
6. Remove the remaining side of film from the adhesive on the bracket and mount the camera. Press and hold the bracket firmly in place for 30 seconds.
7. Route the camera cable up to the headliner.
8. Power on the unit and connect to the Wi-Fi to view the live camera image to properly aim it on the view page. (See [Viewing Cameras on a Smart Device](#) for connection details)
9. After the camera is aimed, tighten the four (4) mounting screws on the sides of the camera.

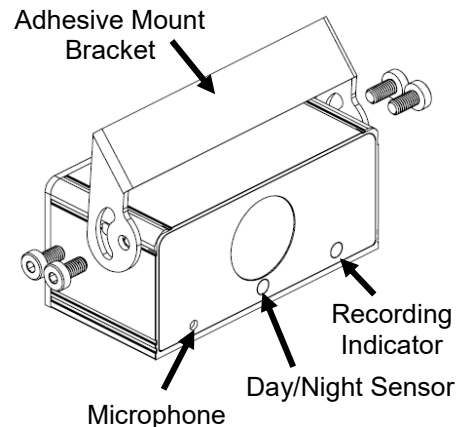

Example view out the front windshield of a Thomas C2 School Bus

Digital HD Side Camera Installation



The Waterproof Night Vision Side Camera (Kit P/N: DVR-814, Camera P/N: PC-1814) is designed to mount on the left or right side of a vehicle and capture video along the side of the vehicle. This camera has a horizontal coverage of a ~75° that provides exceptional capability to capture street signs, license plates, and other details not normally captured by wide angle cameras. This camera is most often used in applications where it is necessary to capture license plates of other vehicles passing the camera. The camera also has night vision and a light sensor to automatically enable the night vision when necessary. With its waterproof IP-67 housing, this camera can be mounted to the exterior of the vehicle and handle all weather conditions.

Mounting Location:

This camera is often used on school buses mounted on the driver’s side near the stop arm to capture license plates of vehicles passing the bus.

The camera can only be mounted to a vertical surface, it can be mounted facing forward or rearward and can adjust up to 90° outward in either position. The camera mounting screw holes are slotted to allow the camera to be aimed upward or downward after mounting.

Installation:

1. Gently spread the two sides of the bracket apart and slide the camera in place with the pivot pins on each side of the bracket aligned to the center hole on each side of the camera as show in the image to the right.
2. Locate the desired mounting location of the camera. It is recommended to power on the DVR unit and temporarily connect the camera to it and observe that the view in the desired mounting location is satisfactory before proceeding to the next step.
3. When the desired mounting location is found, mark or measure the two (2) mounting screw hole locations in the bracket (Shown in **ORANGE** at right). If necessary, remove the camera from the bracket.
4. If the cable will be routed through the vehicle body, typically it is routed through a 5/8” holed drilled directly in the center of the vehicle body behind the bracket (Shown in **RED** color above). Mark and drill this hole if needed. Remove any burrs from the hole to prevent damage to the cable.
5. Install the camera bracket to the marked locations from step 3 (Shown in **ORANGE** above). Ensure the bracket is oriented for properly aim as shown in the image at right, if needed flip the bracket 180°.
6. Install the camera into the bracket by spreading the bracket apart slightly and aligning the center holes on each side of the camera with the pivot pins on the bracket.

Vertical Mount Only

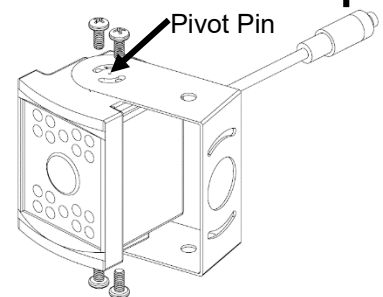
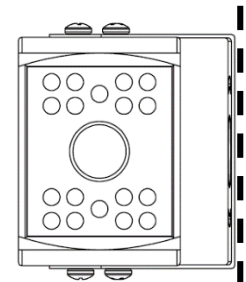

Direction of Camera Aim

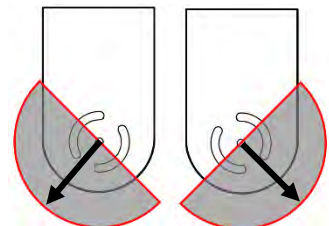

7. Route the camera cable through the mounting hole in the center of the bracket (if applicable) and install a grommet or put adhesive around the cable to provide a seal with the hole.
8. Route and install the extension cable(s) to the cameras final mounting location and connect it to the camera. Leave enough slack to allow removal of the camera. (Typically 4-6")
9. Install the four (4) side mounting screws into the side of the camera through the bracket using a lock washer and washer on each. Do not tighten the screws until the final aim is set.
10. Power on the DVR unit and connect to the Wi-Fi to view the live camera image to properly aim it on the view page. (See [Viewing Cameras on a Smart Device](#) for connection details)
11. After the camera is aimed, tighten the four (4) mounting screws on the sides of the camera.



Example view of driver's side rear facing on a Thomas C2 School Bus

Digital HD Exterior Camera Installation



The Waterproof Night Vision Camera (Kit P/N: DVR-816, Camera P/N: PC-1816) is designed to mount on the rear of a vehicle and capture the area directly behind the vehicle. This camera has a horizontal coverage of a ~120° that provides a clear image of objects while covering a wide area. This camera is often used in applications where capturing a clear and detailed view both day and night is important. The camera has built in high intensity night vision and a light sensor to automatically enable the night vision when necessary. With its waterproof IP-67 housing, this camera can be mounted to the exterior of the vehicle and handle all weather conditions.

Mounting Location:

This camera is often used on the rear of the bus to provide video capture backup incidents and traffic behind the bus. The camera can only be mounted to a horizontal surface, it can be mounted above, below, or directly to the mounting surface and can adjust up to 180°. The camera mounting screw holes are slotted to allow the camera to be aimed left or right after mounting.

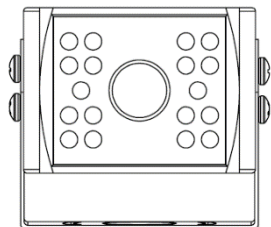

Installation:

17. Gently spread the two sides of the bracket apart and slide the camera in place with the pivot pins on each side of the bracket aligned to the center hole on each side of the camera as show in the image to the right.
18. Locate the desired mounting location of the camera. It is recommended to power on the DVR unit and temporarily connect the camera to it and observe that the view in the desired mounting location is satisfactory before proceeding to the next step.
19. When the desired mounting location is found, mark or measure the two (2) mounting screw hole locations in the bracket (Shown in **ORANGE** at right). If necessary, remove the camera from the bracket.
20. If the cable will be routed through the vehicle body, typically it is routed through a 5/8" holed drilled directly in the center of the vehicle body behind the bracket (Shown in **RED** color above). Mark and drill this hole if needed. Remove any burrs from the hole to prevent damage to the cable.
21. Install the camera bracket to the marked locations from step 3 (Shown in **ORANGE** above). Ensure the bracket is oriented for properly aim as shown in the image at right, if needed flip the bracket 180°.
22. Install the camera into the bracket by spreading the bracket apart slightly and aligning the center holes on each side of the camera with the pivot pins on the bracket.

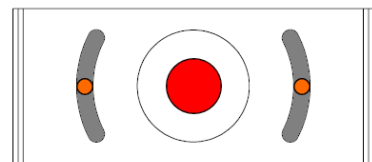
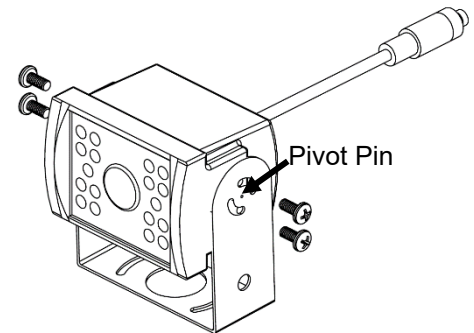

Direction of Camera Aim

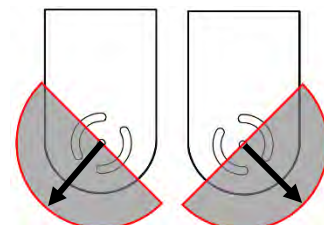

23. Route the camera cable through the mounting hole in the center of the bracket (if applicable) and install a grommet or put adhesive around the cable to provide a seal with the hole.
24. Route and install the extension cable(s) to the cameras final mounting location and connect it to the camera. Leave enough slack to allow removal of the camera. (Typically 4-6")
25. Install the four (4) side mounting screws into the side of the camera through the bracket using a lock washer and washer on each. Do not tighten the screws until the final aim is set.
26. Power on the DVR unit and connect to the Wi-Fi to view the live camera image to properly aim it on the view page. (See [Viewing Cameras on a Smart Device](#) for connection details)
27. After the camera is aimed, tighten the four (4) mounting screws on the sides of the camera.

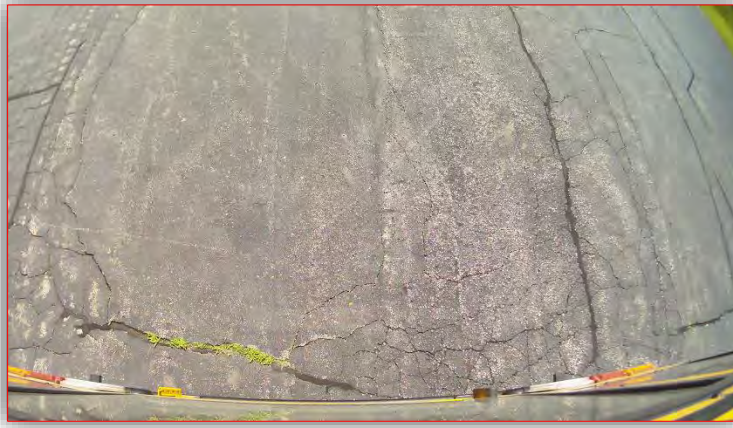

Example view from the rear of a Thomas C2 School Bus

Digital HD Super Wide Angle Camera Installation



The Super Wide Angle Camera (Kit P/N: DVR-818, Camera P/N: PC-1818) is designed to provide superior coverage inside the vehicle. The camera is very similar to another camera model (DVR-813) visually, but this camera has a wider field-of-view and two infrared (IR) LED's to the left and right of the camera lens. This camera has a super wide 175° horizontal field-of-view that allows it to cover door-to-door even when it is not mounted centerline of the vehicle. However, the best location for coverage is mounted centerline of the vehicle. The camera has a sensor to turn the IR LED's on/off as required. A microphone is built into the front of the camera. There is also a red LED on the front of the camera that will flash to indicate the recording status.

Mounting Location:

The mounting location depends on vehicle type and desired coverage. Most often the camera is used for additional coverage in the rear area of the vehicle for passengers or cargo. The camera is very small and lightweight and can be mounted directly to a metal surface, plastic panel, or the vehicle headliner.

On most buses the camera is mounted directly above the wire panel running above the side windows of the passenger area. Do not mount camera with any light source directly in the field of view as it will affect the picture quality.

Standard Bracket Installation:

1. Slide the bracket over the top of the camera and loosely attach two of the camera's side attachment screws through the round (not slotted) holes on each side.
2. Hold the camera in the desired mounting location. Ensure that the remaining two (2) camera side attachment screws will line up through the slots. If the holes do not line up, then the bracket will need to rotated 180 degrees to provide proper adjustment for installation.
3. It is recommended to power on the DVR unit and temporarily connect the camera to it and observe that the view in the desired mounting location is satisfactory before permanently attaching the camera and routing the cable(s).
4. When the desired mounting location is found, mark or measure the two (2) mounting screw hole locations in the bracket (Shown in **ORANGE** at right)
5. Remove the side attachment screws and then put the bracket in its mounting location using the marks or measurements made in the previous step.
6. Use the included self-tapping mounting screws to attach the bracket to the mounting location. If there is not adequate strength in the mounting surface or adequate space behind it then bolts, nuts, and washers should be used for mounting.

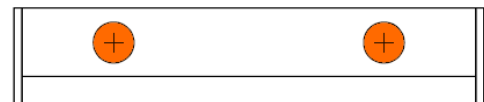
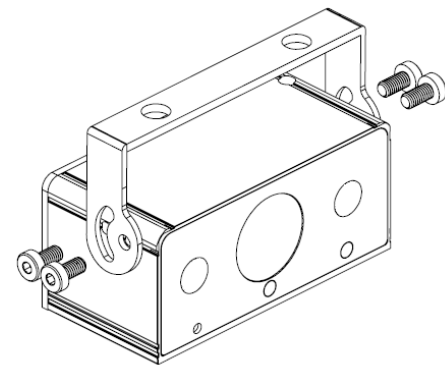

7. If mounting directly to headliner, where the camera cable must go through headliner, remove one mounting screw, temporarily remove bracket, then drill a 5/8" hole (Shown in **RED** below) between the mounting holes. Feed the camera cable (Shown in **YELLOW** below) through it, then reinstall the bracket leaving the cable to the front or rear of the bracket. This method uses the bracket to cover the hole that the cable was routed through.

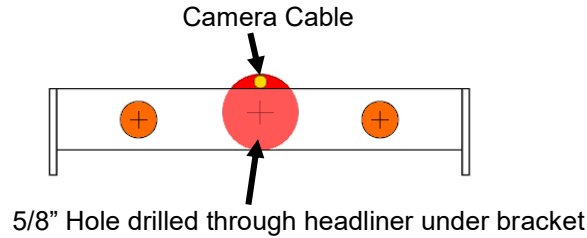

8. Install the camera into the bracket using the four (4) camera side attachment screws; leave the screws slightly loose until the camera is aimed.
9. Power on the DVR unit and connect to the Wi-Fi to view the live camera image to properly aim it on the view page. (See [Viewing Cameras on a Smart Device](#) for connection details)
10. After the camera is aimed, tighten the four (4) mounting screws on the sides of the camera.



Example views showing inside of front and cargo area of van

Alternate Flush Mount Bracket Installation:

1. Determine the approximate mounting angle of the camera by holding the camera flat against the surface of the panel to be flush mounted. Connect it to the DVR, and then power on the DVR. (See [Viewing Cameras on a Smart Device](#) for connection details) Observe the camera view and determine if it will need to be aimed upward or downward and approximately to what degree angle. The bracket has five (5) mounting positions:
-20° -10° 0° +10° +20°.

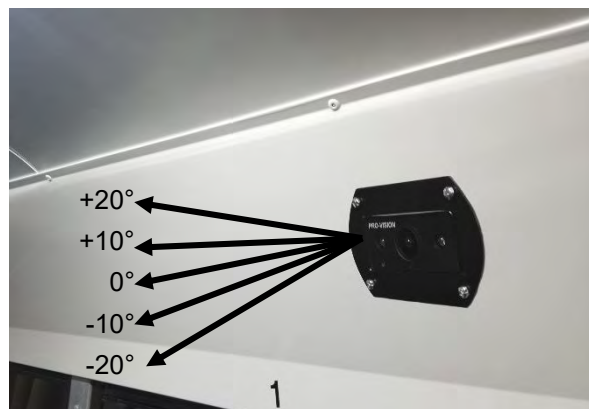

- Ensure that there is sufficient clearance behind the panel to allow the camera to be mounted; 1.25" of clearance is required.

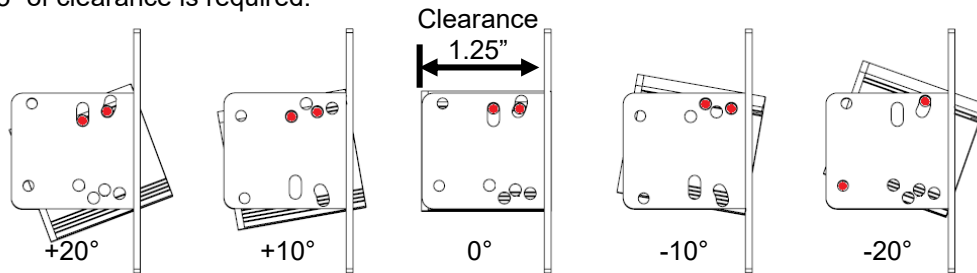

- Determine the orientation of the mounting bracket by the desired mounting angle. Observe the image above and the desired mounting angle and align the holes as show in **RED** color with the camera's mounting holes
- Install the four (4) side mounting screws in the sides of the cameras according to the holes in **RED** color above. For mounting in the -20° angle configuration, the rear two (2) screws will be threaded into the bracket only to prevent the camera from rotating.
- Hold the camera back in the desired mounting location and observe the view on the DVR, but this time hold the camera with the bracket face parallel to the mounting surface, this will simulate the camera's final mounting view. If the mounting angle needs to be adjusted, repeat steps 3-4 at this time.

- Measure, mark, and drill the two main holes for the camera to recess into, the holes are 1.25" diameter and 2" apart as shown in **RED** color to the right.
- Use a shears or grinding tool to cut the remaining material between the two holes out as shown in **AMBER** color to the right.

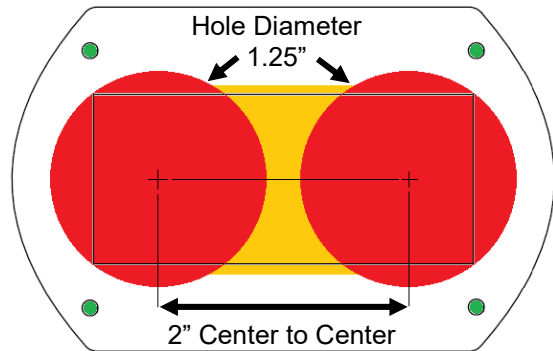

- Insert the camera and bracket assembly through the newly cut mounting hole with the cable first. After the camera is in the hole ensure that the bracket sits flush with the mounting surface. If any of the mounting surface was deformed during the drilling or cutting use a file or deburring tool to remove the deformation so the bracket sits flush.
- Use the four (4) included self-tapping mounting screws to attach the bracket to the mounting location in the mounting holes shown above in **GREEN** color. If there is not adequate strength in the mounting surface or adequate space behind it then bolts, nuts, and washers should be used for mounting.
- Power on the DVR unit and connect to the Wi-Fi to view the live camera image to ensure the view is as desired. Remove the screws from the bracket and then repeat steps 3, 4, and 9 until the best of the five (5) available aim it is selected.

Digital HD Wide-Angle Exterior Camera Installation



The Wide-Angle Exterior Camera (Kit P/N: DVR-820, Camera P/N: PC-1820) is designed to provide coverage around the outside of the vehicle. The camera is waterproof rated IP-67 and has a wide-angle lens that can capture a wide area around the outside of the vehicle. The camera is designed to be mounted directly to a vehicle exterior body panel. The camera has six (6) infrared (IR) LED's that provide illumination during low light/dark conditions. The camera also has a waterproof microphone built into the camera housing.

Mounting Locations:

The camera provides a 175° field-of-view allow nearly complete coverage of whatever side of the vehicle it has been mounted and aimed to cover. For coverage of the side of a vehicle, the camera is typically mounted directly to the roof or side of vehicle body near the roof facing outward perpendicular to the direction of vehicle travel at a slight downward angle. The camera should be mounted as close to the outside edge of the roofline as possible to prevent blind spots directly next to the vehicle. Always check the mounting structure under the camera to ensure that proper access to route the cable is possible.

Installation:

11. Remove the three (3) Allen head cover mounting screws from the camera and then remove the camera ball and cable.
12. With just the camera base and gasket, hold in desired mounting location and mark the three (3) camera base mounting screw locations (shown in **ORANGE** color below right).
13. It is recommended to power on the DVR unit, temporarily connect the camera to it, set the camera in the mounting base (with gasket attached), and observe that the view in the desired mounting location is satisfactory before permanently attaching the camera and routing the cable(s).
14. Remove the mounting gasket from the base and hold the base aligned over the previous screw marks. Now mark the center of the large hole underneath the dome base portion previously covered by the gasket (shown in **RED** color in the diagram to the right). This hole will be drilled to 5/8" to route the cable out of the camera. **DO NOT DRILL** any holes until you are certain of and have verified the cameras mounting location.

IMPORTANT: Do not drill out any of the holes shown in **GRAY** color in the image to the left. They are not used for mounting or routing the cable through the vehicle body.

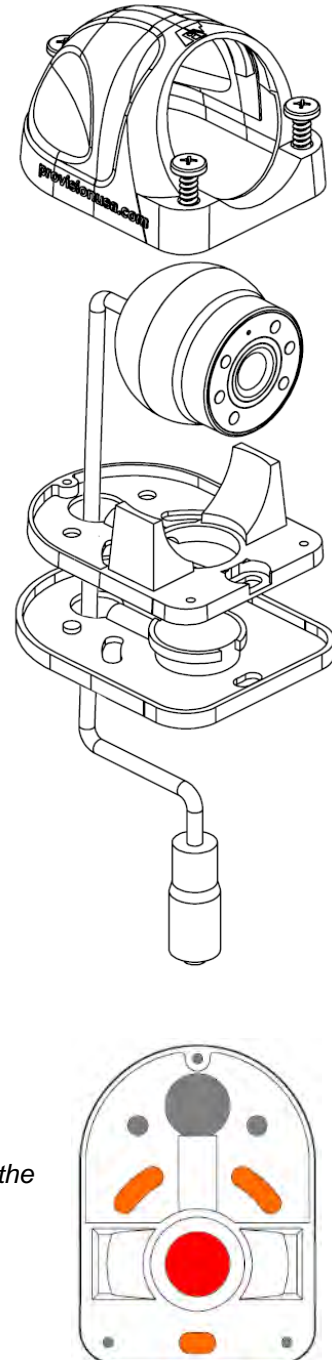

15. If you are certain of the cameras mounting location and that the correct hole for the cable has been drilled, then attach the gasket to the camera base, route the camera cable through the base and gasket, and then through the 5/8" hole and hold the camera in its mounting location. The camera cable should make an "S" shape as it travels out the back of the dome ball, through the hole in the base, then back through the hole drilled in the mounting surface under the dome ball.
16. Use the mounting hardware provided to attach the camera base to the mounting location. Check behind the mounting surface to ensure the hardware has clearance. **DO NOT** completely tighten hardware yet.
17. Place the dome ball into its socket in the camera base and ensure there is enough camera cable to move the camera ball, but not too much. Feed any additional camera cable slack back behind the mounting hole/surface and then tighten mounting hardware.
18. Attach the camera cover to the camera with the three (3) Allen head mounting screws. Leave the screws slightly loose until the camera is aimed.
19. Power on the DVR unit and connect to the Wi-Fi to view the live camera image to properly aim it on the view page. (See [Viewing Cameras on a Smart Device](#) for connection details)
20. After the camera is aimed, tighten the three (3) Allen head mounting screws to lock the camera aim.

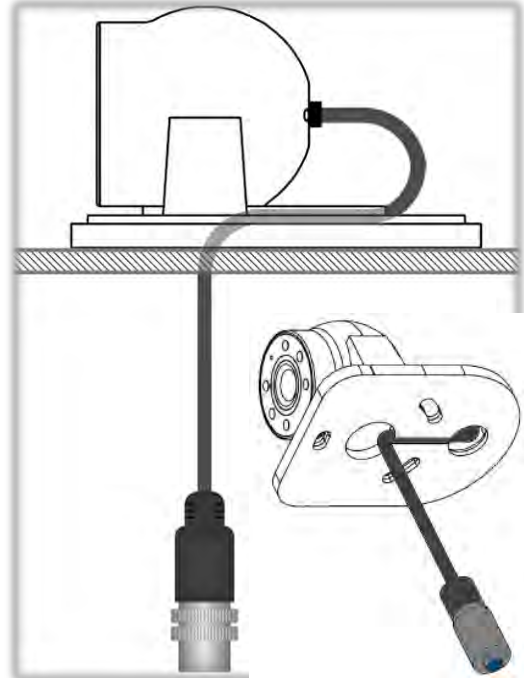

Example view of driver's side of delivery van

Digital HD Mini-Dome Camera Installation



The HD Mini-Dome Camera (Kit P/N: DVR-821, Camera P/N: PC-1821) is designed to be mounted inside a vehicle. The camera is used most often inside the passenger seating areas inside buses and trains, but it also works well in the cargo area of box trucks and vans. It has a built-in microphone for audio recording as well as built-in night vision LED's with an automatic sensor for capturing video in low-light conditions. Its small form factor and high adjustability allow this camera to be mounted in a multitude of interior locations. This camera is not waterproof and cannot be mounted outside a vehicle.

Mounting Location:

The ball and socket dome design allows 360° rotation around the base, 180° adjustment perpendicular to the base, and 360° rotation to level the image. The camera typically is installed with the cable going through a panel directly underneath the mounting location to hide the cable, but it can also be installed where the cable exits the side of the base if there is no room to route the cable behind the camera's mounting location.

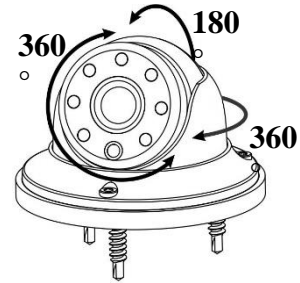

Installation:

10. Disassemble the camera by removing and setting aside the three (3) hex head screws located on the locking ring. Lift up on the locking ring and camera housing to remove them from the camera assembly. Remove the camera ball and pull the cable through the mounting base and rubber mounting gasket.
11. Find the desired camera mounting location and hold the mounting base and rubber gasket up in position.

IMPORTANT! *The notch and cable groove in the camera base should face away from the intended mounting direction of camera ball.*

12. Mark the three (3) mounting holes using a marker (Shown in **ORANGE** above right).
13. If the cable is going to be routed through the center cable hole and into a panel, mark the center cable hole as well (shown in **RED** above right).
14. If applicable, drill out the marked center hole to 1/2" using a drill bit or step drill bit. Clean up any sharp edges to prevent damage to the cable.
15. If the camera cable will exit through the cable groove in the mounting base and not directly into a panel, the cable must be routed through the cable groove before mounting the base to the panel.
16. Align the camera base over the marked screw holes and then using a cordless drill with Phillips bit, install the three (3) self-tapping mounting screws.

Three (3) Mounting Holes

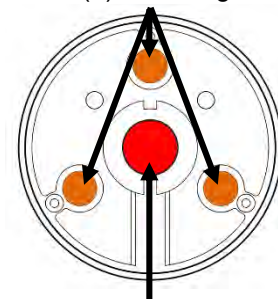

1/2" Center Cable Hole

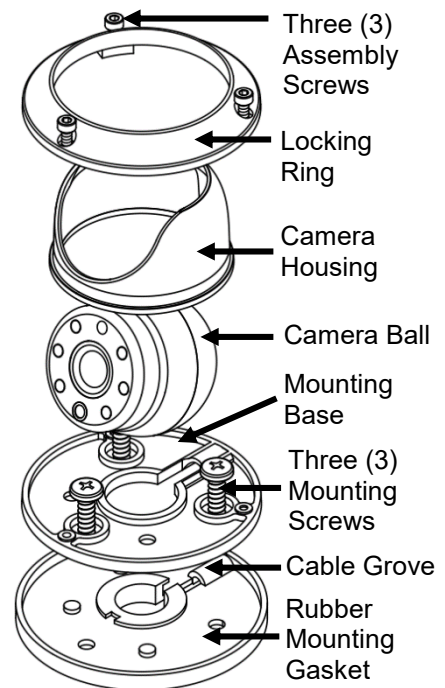

17. Connect the camera connector to the cable running to the DVR unit, if it is not yet installed, install the cable at this time and then continue to step 9.
18. Hold the camera ball and feed any excess cable through the hole or cable groove in the mounted base until the camera ball is resting on the center of the rubber gasket.
19. Place the camera housing and then the locking ring over the camera ball. Ensure that the three (3) mounting screw holes on the locking ring align with the holes in the mounting base.
20. Using a 2mm Allen wrench, begin to tighten each of the three (3) screws; leave the screws slightly loose to allow the camera ball to freely move until the final camera aim is completed.
21. Power on the DVR unit and connect to the Wi-Fi to view the live camera image to properly aim it on the view page. (See [Viewing Cameras on a Smart Device](#) for connection details)
22. When finished aiming, fully tighten the three (3) assembly screws.



Example view of the cargo area of a Dodge Ram Cargo Minivan

Digital HD Dual-Lens Stop-Arm Camera Installation



The HD Dual-Lens Stop-Arm Camera (Kit P/N: DVR-824 Camera P/N: PC-1824) is designed to capture license plates and faces of drivers that pass a school bus while the bus is stopped and has its flashing red lights and stop-arm open. The camera is waterproof (IP-67 rated) and has two (2) lenses with low-light image sensors set at 45° angles to the side of the bus that can provide 180° of coverage on the road side of the bus. The camera is designed to be mounted directly to the bus, parallel to the road with four (4) self-drilling Phillips head screws. The camera also has a waterproof microphone for audio capture.

Mounting Locations:

The camera must be mounted parallel to the road surface on the driver’s side of the bus. The open stop-arm should be partially visible in the camera field-of-view, but not so much as to obstruct vehicle license plate capture.

Recommended mounting: (shown at right)

- 6-18” below the bottom of the stop sign on the stop-arm itself
- 12-60” from the center of the open stop arm forward or rearward



On most bus models, mounting in the area forward of the stop arm provides faster and easier wire routing to the DVR.

The camera must be orientated such that the two (2) 4 mm socket head bolts screw in from the bottom and the “PV” logo is upright facing toward the center of the road. The proper orientation of the mounting bracket and camera are marked with “UP ↑”.

IMPORTANT! For the first installation of each different vehicle model variation it is recommended to temporarily connect the camera, without the mounting base assembly attached, to the recording unit. Power the system on and then hold the camera in the desired mounting location to observe the view to confirm it is satisfactory before continuing.



Shown above is a view from the stop-arm camera mounted forward of the stop-arm on a bus. Note that the stop arm is partially in the view when open but not obstructing license plate capture

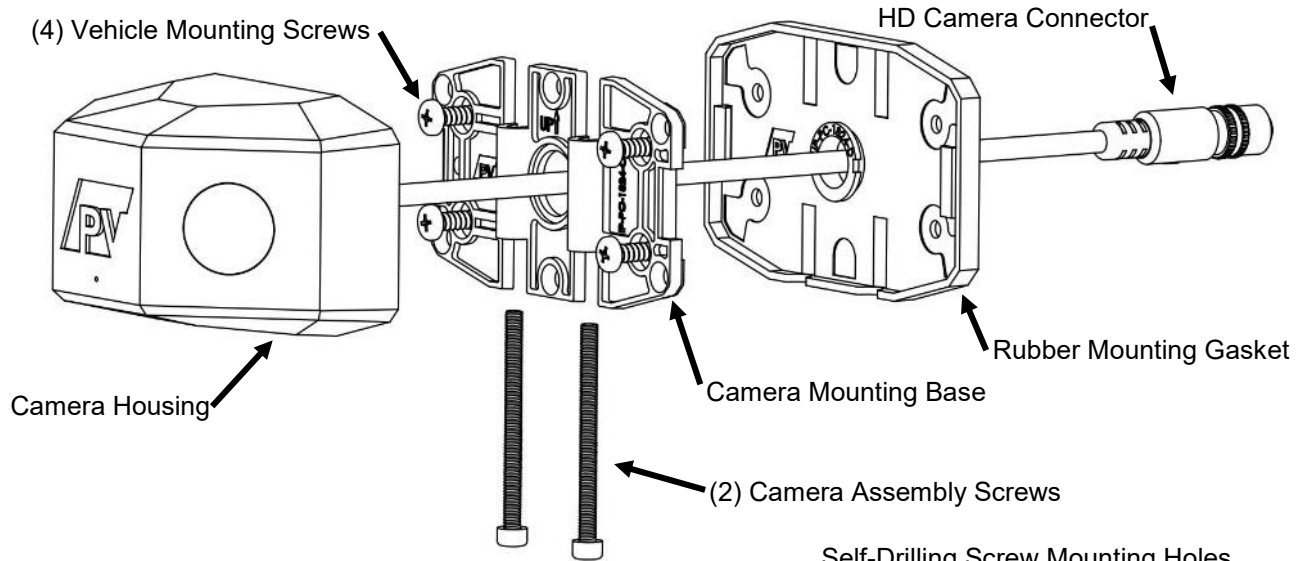

Installation:

1. Attach the camera mounting base to the rubber mounting gasket as shown to the right. Hold the mounting base assembly to the desired mounting location and ensure the base is parallel to the body lines on the side of the bus. Mark the center of the four (4) camera base mounting screw locations (shown in **ORANGE**) and the large center cable hole (shown in **RED**).
2. Place the camera mounting base assembly aside and then verify that there is clearance behind the four (4) marked mounting screw locations, as well as clearance and access to behind the one (1) large marked cable hole location.
3. Drill a 1/2" diameter hole in the center marked location (shown in **RED** above). **DO NOT DRILL THE OTHER HOLES.**
4. Using the female end of the camera connection or extension cable, verify there is enough clearance for the connector to fit through the hole and route toward the recording unit. If needed, drill the 1/2" hole out to 3/4" to allow the connector to route into the vehicle body.
5. If certain of the camera's mounting location and that the correct hole for the cable has been drilled, place the mounting base assembly so that the four (4) **ORANGE** marks completed in **Step 1** are showing. Orient the mounting base assembly so that the bolt cutouts in the base and gasket point toward the ground and the "UP↑" points toward the roof of the bus. Use the four (4) self-drilling screws provided to attach the base and gasket to the side of the bus.

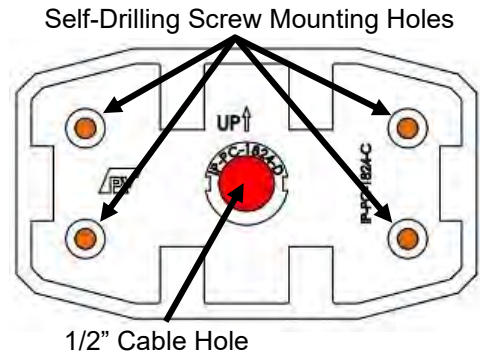

6. After the base and gasket are securely attached to the bus, route the camera cable through the drilled center cable hole and place the camera in the mounting base assembly. Orient the camera so that the bolt cutouts in the housing are pointed toward the ground and the "UP ↑" points toward the roof of the bus as shown to right.
7. Slide the two (2) 4 mm bolts into the bottom of the camera connecting the camera housing to the mounting base assembly. Using the provided 3 mm ball end Allen wrench, tighten the bolts into the Nyloc nuts that are attached to the bottom of the housing. The bolts should be nearly flush with the rubber gasket when fully tightened.
8. Connect the camera cable to the extension cable running to the DVR, and then connect the extension cable to the "Camera 7" port on the DVR unit for the camera to be recognized.

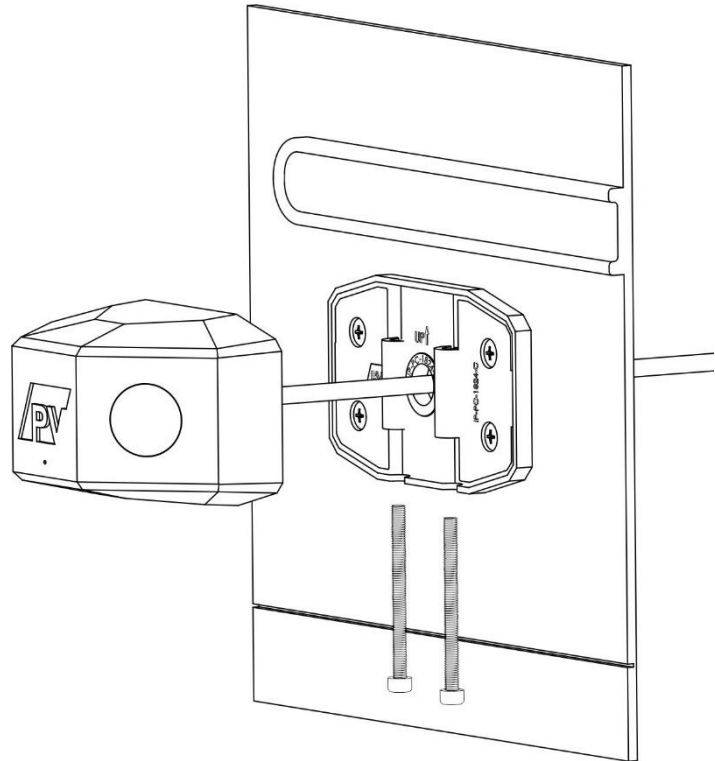

IMPORTANT! *The Nyloc nuts used for mounting the camera experience reduced holding performance after each removal and reinstallation. If the camera is removed and reinstalled multiple times, it is recommended to apply a medium-strength liquid thread locker (such as Permatex® Threadlocker Blue) to the end of the bolt threads or inside of Nyloc nuts before reassembly.*

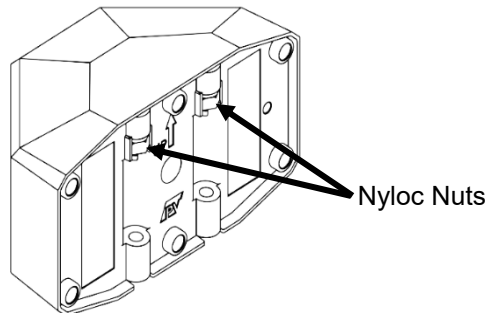

Stop-Arm Camera Triggering:

The stop-arm camera contains an automatic detection function to automatically detect cars passing and generate small video clips that are easy to locate and find for violations. The detection function relies on an external trigger to the DVR unit to tell it when the stop-arm is open to begin detecting vehicles. To use this function, a 12V constant signal from the vehicle when the stop-arm is open must be connected to one of the trigger inputs of the DVR and then configured in the DVR web interface in [Settings > Stop-Arm Camera](#).

Display Installation

There are multiple different monitors available that installed in the vehicle and connected to the DVR. The DVR unit includes a standard RCA video output for temporary display connection and aiming.

5", 5" Waterproof, and 7" HD Monitor Kits

The 5", 5" Waterproof, and 7" Monitors all share the same mounting and installation instructions, they have the same connections and have similar mounting hardware.



1. Determine monitor mounting location and then decide which mount will be used. The U-shaped mounting bracket works well mounting to the dash or ceiling. The adjustable fan mounting bracket works well adhesive mounted to dashboards or windshields, it also can be screw mounted.
2. Use the included mounting hardware and install the mounting bracket. If the adhesive mount is to be used, hold the mount against the desired location and check to see if it fits well, if there is a curve to the surface, bend the bracket slightly to match the mounting surface before adhering. Remove the adhesive backing and then firmly press the mount to the surface and hold for 30 seconds. It is recommended to allow adhesive to cure for 1 hour prior to attaching monitor.
3. Locate your ignition controlled power and ground locations in the vehicle. A fused location is not needed as the power harness for the monitor includes an inline fuse.
4. Make the proper connections to the red and black wires on the power harness to the vehicle power connection as noted in the diagram below. The green wire is not necessary for this application.
5. Route the power harness large female connector to the mounting location of the monitor.
6. Mount the monitor to the mount and make the connection from the monitor to the monitor power harness. Make note of the connector alignment arrows making the connection.
7. If the monitor power harness CAM 1 connector is further than 3 ft. from the DVR, use a 5m AV cable to connect the monitor power harness to the DVR output.
8. Connect the PX-1942 5M A/V cable to the CAM 1 (Camera 1) input of the monitor power harness, then run the male end to the PD-1776 DVR to Monitor Interface Cable.
9. Connect the CAM 1 Trigger (White) to a triggered power source if it is desired to have the monitor automatically turn on in when triggered; a trigger connection is not required as the monitor can be manually powered on with the power button.

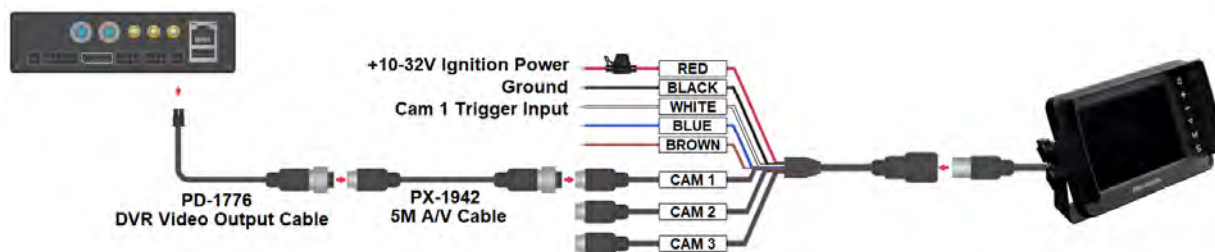

10.1" HD Monitor Kit



1. Determine monitor mounting location and then decide which mount will be used. The U-shaped mounting bracket works well mounting to the dash or ceiling. The adjustable fan mounting bracket works well adhesive mounted to dashboards or windshields, it also can be screw mounted.
2. Use the included mounting hardware and install the mounting bracket. If the adhesive mount is to be used, hold the mount against the desired location and check to see if it fits well, if there is a curve to the surface, bend the bracket slightly to match the mounting surface before adhering. Remove the adhesive backing and then firmly press the mount to the surface and hold for 30 seconds. It is recommended to allow adhesive to cure for 1 hour prior to attaching monitor.
3. Locate your ignition controlled power and ground locations in the vehicle. A fused location is not needed as the power harness for the monitor includes an inline fuse.
4. Make the proper connections to the red and black wires on the power harness to the vehicle power connection as noted in the diagram below. The green wire is not necessary for this application.
5. Route the power harness large female connector to the mounting location of the monitor.
6. Mount the monitor to the mount and make the connection from the monitor to the monitor power harness. Make note of the connector alignment arrows making the connection.
7. If the monitor power harness CAM 1 connector is further than 3 ft. from the DVR, use a 5m AV cable to connect the monitor power harness to the DVR output.
8. Connect the PX-1942 5M A/V cable to the CAM 1 (Camera 1) input of the monitor power harness, then run the male end to the PD-1776 DVR to Monitor Interface Cable.
9. Connect the CAM 1 Trigger (White) to a triggered power source if it is desired to have the monitor automatically turn on in when triggered; a trigger connection is not required as the monitor can be manually powered on with the power button.

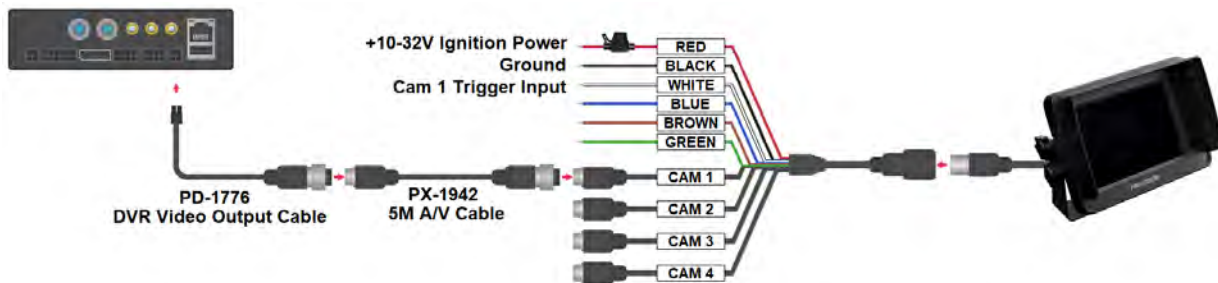

External Trigger Inputs

The unit has three (3) auxiliary trigger inputs located on the PD-1833 GPS / Event / Triggers cable at the rear of the unit. Each trigger input can be used in a variety of ways. The trigger inputs are used to trigger alarm recordings, to display a four-character word on the recording, to generate an alert email, to trigger an audible alarm, or a combination of all events.

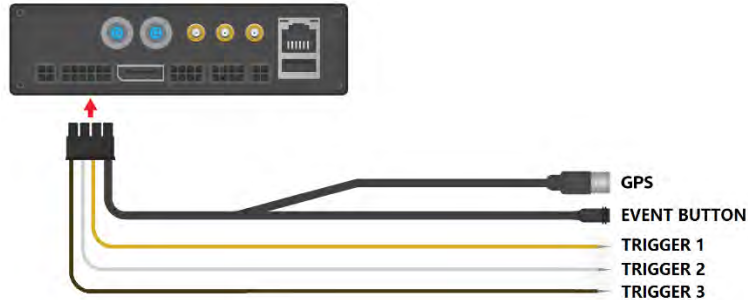

How Trigger Inputs Work:

The standard setting for the trigger inputs is such that when a 12V signal is sent to a trigger wire, an alarm recording will be triggered to start, and a corresponding four-character acronym will display on the screen.

Example: When Trigger 1 receives 12V, "T1" will display on the video by default.

When the 12V signal is removed, the four-character word will no longer display on-screen and the DVR will continue the alarm recording for a preset amount of time (Post-Event Recording).

Configurable Trigger Input Settings:

- The three (3) trigger inputs can be set independently to receive a high-level signal (1V to 24V DC) or a low-level signal (GROUND).
- The three (3) trigger inputs can be set independently to display any four-character phrase; characters include capital letters A-Z and numbers 0-9. Examples: "PTO", "DOOR", "OHL3", "BRK4", "DR11."
- The three (3) trigger inputs can be set independently to turn alarm recording ON or OFF by camera.
- The Alarm recording can be configured to have Pre-Event Recording of 0-60 seconds. Pre-Event Record Time is a segment of video prior to the activation of the trigger that will be added to the beginning of the alarm recording.
- The Alarm recording can be set to perform a Post-Event Recording of 0-180 seconds. Post-Event Record Time is the time that the DVR will continue an alarm recording after a trigger signal has been removed.

Connecting Trigger Inputs:

To connect each trigger input, determine the trigger signal type: 12-24V Signal, the level will be set to "HIGH" (Default), Ground (-) signal will require the level to be set to "LOW" for the trigger.

After your trigger source has been located, run a wire from the source to the desired trigger input on the GPS/Event/Trigger Cable.

Wi-Fi Antenna Installation

There are two (2) Wi-Fi antennas included with the system, they are both identical and can be connected to either of the two (2) Wi-Fi connection ports on the rear of the DVR unit. At least one antenna is needed to allow configuration of the unit through Wi-Fi. The second antenna is recommended for use in situations where the unit will connect to a building's Wi-Fi for file transfer. The second antenna does not increase range of the Wi-Fi; it increases the overall data transfer speed.

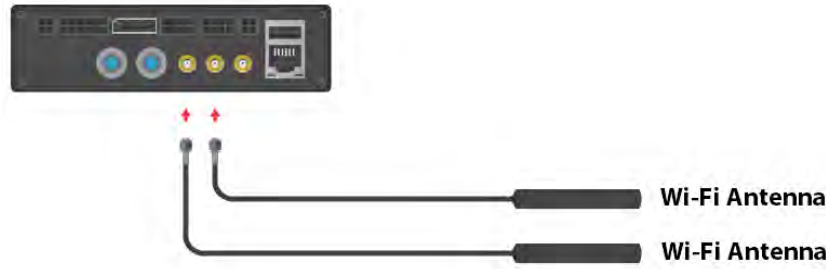

Installation Restrictions

- The antennas must be installed at least 20 cm (7 7/8") from any person in their normal, seated position.
- The antennas must be installed at least 20 cm (7 7/8") from any other antenna.
- Use only 2 dBi, vertical polarized, dipole antennas provided by PRO-VISION. Use of any other antenna voids the warranty and removes the user's authority to operate the equipment.
-

Recommended Installation:

- The antennas should be at least 6" from each other.
- The antennas perform best when installed vertically.
- Metal panels and tinted glass reduce the range and effectiveness of the antenna.
- Common locations are in the front windshield, or in the front bulkhead area (on vehicles with fiberglass front exterior headers only).
- The antennas should be installed with the best line of sight to the buildings Wi-Fi access point.

Event Marker Button Installation



The Event Marker Button (P/N: PD-1770) is used to provide the driver an easy way to mark Normal video as an important Alarm Video and to serve as a marker to mark a point of importance within an Alarm video. The button also provides the driver with a clear indicator of the system operation.

Recommended Mounting Locations:

The button should always be mounted within reach of the driver while seated normally and buckled. The LED status light on the button should be visible either directly or indirectly (reflected off a nearby dash or console) by the driver. If unsure of the button location or LED brightness it is recommended to temporarily power the DVR unit with the button connected prior to installing to observe the LED visibility. The buttons are commonly mounted to the dash to the left of the gauge cluster, to the upper driver's side corner of the windshield (to the glass) or on the center console.

Installation:

The Event Marker Button includes 6m (20 ft.) of cable. This cable needs to be routed starting from the button location to the PD-1833 GPS/Event/Trigger Interface Cable at the rear of the DVR. The button is usually mounted within reach of the driver using the included adhesive pad. When mounting the button, be sure to rotate the button so that the LED light faces in the proper direction.

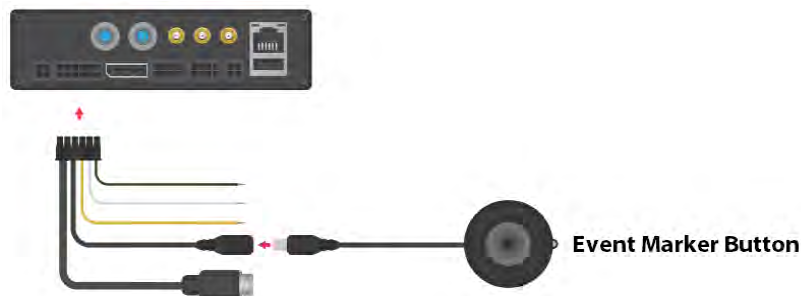

LED Light:

The event marker button LED will begin to flash green while the DVR is booting, once booted and the disk is loaded it will switch to solid green when it begins recording.

FLASHING GREEN - ON but not recording

SOLID GREEN - Recording normally

FLASHING RED - Not recording due to problem, LED will also momentarily flash red when button is pressed

SOLID RED - Hardware problem/button malfunction

GPS Receiver Antenna Installation



The GPS Antenna (P/N: PD-1750) provides GPS data to the DVR, this data includes vehicle speed, location, and current date/time. The data can be used to trigger events, map the vehicles location during playback, as well as synchronize date/time with the DVR.

Recommended mounting locations:

Typically the GPS Antenna is mounted to the dash in front of the driver close to the windshield.

Unsure about mounting location?

If you are unsure about your GPS mounting location providing proper signal strength, power on the DVR unit with the GPS antenna connected prior to installing it, the GPS antenna will have a red LED light come on underneath the “GPS” print. This light will flash red if a signal cannot be acquired, and will be solid red if acceptable signal strength is acquired. Ensure the vehicle is outside, and then place the antenna in the desired location, if the LED light stays solid red then that location is suitable for mounting. If the LED light flashes red in the mounting location, then the signal is not acceptable and an alternate location will need to be found.

The buttons are commonly mounted to the dash to the left of the gauge cluster, to the upper driver’s side corner of the windshield (to the glass) or on the center console.

Installation:

The GPS Receiver Antenna has 4m (13 ft.) of cable. Because of the size of the antenna, it is best to start routing this cable from the antenna location to the DVR. The black 4-pin connector on the antenna will connect to the 4-pin “GPS” connector on the PD-1833 GPS / Event / Triggers at the rear of the DVR unit. The GPS Antenna is waterproof and can be exterior mount, but can provide a good signal when mounted in the vehicle interior. It can be fixed to the mounting surface using the included adhesive, the built-in magnet, or simply placed on the surface if mounted in the front dash or rear deck.



Solid-State Drive (SSD) Installation



The DVR has the capability of adding an additional high capacity solid state storage device. This drive can be used in addition to or instead of the included SDXC Card.

Solid-State Drives (SSD's) are available in the following configurations:

- DVR-830 – 500GB
- DVR-831 – 1TB
- DVR-832 – 2TB

Installation:

To install, remove the two Philips head screws on the the “PRO-VISION” front panel on the DVR and then slide the SSD in the open slot. Use the same screws to secure the SSD in place.

The DVR will default to storing information on the SSD even if a removeable SDXC card is installed in the DVR. When the SSD is full, the DVR will write over the non-alarm data files. It will write to the removeable SD installed only when the SSD is completely full of alarm data. The DVR settings can be changed to prevent writing over existing data. If that option is chosen, the data will need to be downloaded and removed from the SSD to allow the DVR to continue recording.

In the event of SSD failure, or if the SSD is removed, the DVR will automatically continue recording to the SDXC card if present.

Caution! Do not remove the SSD from the its mounting tray, this tray includes all the relavent warranty information for the product including is size identification and serian number. If the drive is removed from the tray the warranty will be void.

After the installation is completed, the DVR must be configured to fully utilize its functionality. This requires the vehicle ignition to be powered ON and a smart device (tablet, laptop, smartphone) to connect and configure the system.

Note: The DVR must be powered ON for configuration; when the DVR is powered ON, the green PWR light will be ON solid. (If the PWR light is blinking, the system is in standby mode.)

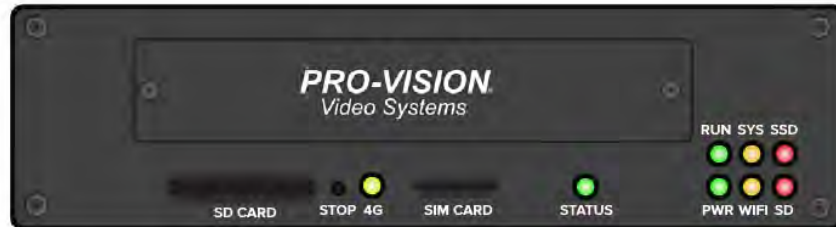

DVR Status Lights

- 4G AMBER Normally OFF. Indicates when the DVR is connected to a 4G network. This light requires the DVR to be configured with the optional 4G modem.
- STATUS GREEN/RED Solid green indicates the DVR is on, operating and recording normally. Flashing green indicates the DVR is still booting up, or is operating properly, but is not set to record. Flashing red indicates the system is operating but cannot record; this can be due to a missing or full storage device or DVR issue.
- PWR GREEN Solid green indicates DVR is on. Blinking with green RUN indicates there is no ignition signal and DVR is in the time-delayed shutoff mode.
- RUN GREEN Blinking indicates DVR is on. Blinking with green PWR indicates there is no ignition signal and DVR is in the time-delayed shutoff mode.
- WIFI AMBER Blinking amber indicates the DVR is connected to a Wi-Fi network.
- SYS AMBER Blinking amber indicates the number of cameras configured to record that are not recording, this requires configuration to be accurate.
- SD RED Flashing indicates data is recording to SD card. Solid indicates the SD card is present but no data is being recorded. OFF indicates no SD card is present.
- SSD RED Flashing indicates data is recording to the solid-state drive. Solid indicates solid-state drive is present, but is not recording. OFF indicates there is no solid-state drive present.

Connecting to the DVR

The DVR can be connected with an Ethernet (LAN) cable to a laptop, or it can also be accessed wirelessly using a Wi-Fi connected laptop, tablet, or smartphone device.

1. Connect to the DVR:
 - a. **LAN:**
Connect a cable from the LAN port on the DVR unit to a LAN port on the laptop using a standard (Non-crossover) LAN cable.
 - b. **Wi-Fi:**
On a Wi-Fi-enabled device (laptop, smartphone or tablet) go to the Wi-Fi settings and connect to the Wi-Fi with the name "PV_HDVR_XXXXXX". The Wi-Fi has a default password of "doesitall".

NOTE: "XXXXXX" is a randomly generated number for each DVR unit sent from the factory.

2. Open a web browser software application such as Microsoft® Internet Explorer®, Mozilla® Firefox®, or Google® Chrome® browser.

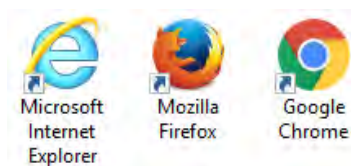

- a. LAN: Type "192.168.10.254" in the browser address bar and press enter.
- b. Wi-Fi: Type "192.168.1.254" in the browser address bar and press enter.

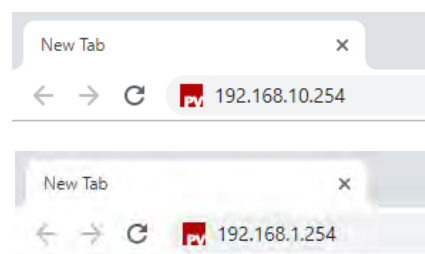

3. You will now be on "PRO-VISION" web interface for the DVR unit. You will see current Unit ID (Default: "PVVS" if not yet configured), the model number (PD-1900), and the device's serial number.

Note: When using a web browser to view the live video, the browser will display JPEG images of the camera views that refresh once per second. If you wish to see live video, connect a display to either the HD or SD video outputs of the rear of the DVR.

Setup Wizard

If you are connecting to the DVR unit for the first time a welcome window will appear asking if you want to be walked through configuration in a step-by-step process. Press "Configure Now" to begin the setup process. If you wish to manually configure the DVR you can choose "Configure Later".

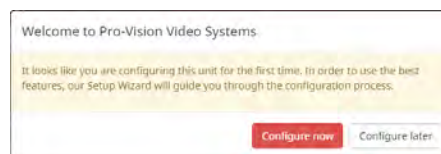

The setup wizard can be accessed from the setting button in the upper right corner of the web page and then selecting "Setup Wizard" to begin the process.

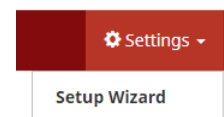

Basic DVR Settings

Basic DVR settings are adjusting by clicking on the settings button in the upper right corner of the web page and then selecting the category from the drop-down menu.

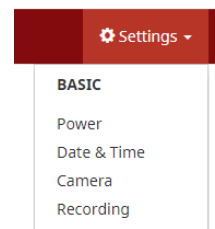

Power Settings:

The power settings allow the user to set when the system turns on and off. By default, the system will turn on with the vehicles ignition and turn off 1800 seconds (30mins) after the key is turned off.

Operation Controlled by:

Set to "Vehicle Ignition" for normal operation, this can be changed to "Schedule" to set certain times of the day to power the system on/off rather than by ignition state.

Operation Controlled by

Stop Recording Delay (after Ignition OFF, continue recording for)
 Seconds

Power Off Delay (after Ignition OFF, power unit down after)
 Seconds

Stop Recording Delay:

Set the number of seconds after the key turns off that the DVR unit will continue to record for. Commonly this is set to 600 seconds (10 min) regardless of the power down time.

Power Off Delay:

This setting is used to configure the amount of time the DVR will continue to remain powered on and active after the vehicle ignition has been turned OFF, this works in conjunction with the "Stop Recording Delay" setting above. If the vehicle is not using Wi-Fi transfer this is commonly set to 600 seconds. If Wi-Fi transfer is used this setting is normally set around 3600 seconds (1 hour) to allow sufficient time to transfer data.

Date & Time Settings:

Date Format:

Allows the user to select which date format as it will appear on the video.

Current Unit Time (24h):

Shows the time the DVR is currently set at.

Set Time:

Allows the user to choose how time is set:

- Sync with GPS (if exists)
- Keep Current Settings - Will not change any time or date information.
- Manually Set - Provides areas where the date and time can be set by the user. Click in each box to enter the text. Once finished, click the "Update" tab at the bottom of the page.
- Sync with Device Time - Shows the current date and time of the device you are using to program your DVR.

Date Format

Current Unit Time (24h)

Set Time

GPS Status

Time Zone

DST Location

GPS Status:

Displays the current GPS status to show if GPS can synchronize the time.

Time Zone:

Select the time zone for your area. This is required if using GPS time sync, if set incorrectly GPS will synchronize to the incorrect time.

DST Setting:

Set Daylight Saving Time for three global regions or disable DST.

Camera Settings:

Select the camera you want to adjust by clicking on one of the numbered red buttons at the top of the screen.

Camera Title:

Enter a unique title for each camera to identify it in the upper left corner of the video.

Camera Lost Alarm:

Enabling this option will cause the DVR to emit a loud "beep" if the camera signal is lost.

Flip Vertically:

Enabling this option will cause the image to flip vertically.

Flip Horizontally:

Enabling this option will cause the image to flip horizontally.

Audio Volume:

This option allows the audio input volume of the specific camera to be adjusted so that audio playback on the computer is even.

Brightness:

Adjust the brightness of the camera image (0-100) 50 default.

Contrast:

Adjust the contrast of the camera image (0-100) 50 default.

Color Mode:

Allows the user to change the color mode or make custom corrections to the image color.

Advanced Settings:

These settings will only work on supported Digital HD Cameras.

IR LED:

Adjust if the IR LED indicators will be used.

LED Indicator:

Adjust if the red LED recording indicators will be used.

Low FPS When Dark:

Adjust if the camera will auto adjust the framerate when IR night vision is used.

Recording Settings:

Configure Cameras:

Select the method of configuring cameras, if you unsure, select "All at Once" to configure all cameras with the same settings.

Video Recording:

Select when the camera(s) will be recording.

Always Record video whenever the unit is on.

Event Only Record video only when triggered by an event.

Never Never record video, camera will only be used for observation.

Audio Recording:

Select when the camera(s) will be record audio.

Always Record audio whenever the unit is on.

Event Only Record audio only when triggered by an event.

Never Never record audio.

Resolution:

The recording resolution for each camera determines the overall amount of pixels recorded, the larger the number the better the image clarity. 1080P is highest, 540P lowest.

Bitrate:

The bitrate is the amount of data used per second for video recording. Higher bitrates will provide the highest picture quality but will also provide the lowest amount of stored video. Lower bitrates will reduce the quality of the video but increase the amount of storage capacity on the disk. Bitrate affects the sharpness, color definition and overall clarity of the image. Low bitrates will provide images without less accurate colors and pixilation of the image.

IMPORTANT! The maximum total bitrate of all cameras must be less than 16,000Kbps when recording to an SD card; a Solid State Disk (SSD) should be used in systems with many cameras at a high bitrate.

Frame Rate:

The framerate is the number of images (frames) captured per second of video. A higher number will provide a smoother video but will reduce the overall image quality if the bitrate is not changed; if the bitrate is increased it will lower the amount of video that can fit on the disk. Lower frame rates will allow for more recorded video and better image clarity but the video will appear more "choppy". The default framerate is 10fps and it is only recommended to increase the framerate for exterior camera views and only if the video is unsatisfactory.

Video File Length:

This setting will determine the maximum length for each video file, the default setting is 10 minutes, so each hour would create 6 video files.

Camera Status:

Shows current state of each camera. If it says "OK" that means the camera is connected and working properly. If it says "No Signal," camera communication has not been established or is not working properly.

Configure Cameras

All At Once

ALL CAMERAS

Video Recording: Always

Audio Recording: Always

Resolution: 1080p

Bitrate(Kbps): 2000

Frame Rate(fps): 10

Video File Length for All Cameras (Minutes): 10

Show All Camera Status

Stop All		Status	Record Status
Stop	CAM1	OK	Recording
Stop	CAM2	OK	Recording
Stop	CAM3	OK	Recording
Stop	CAM4	OK	Recording
Stop	CAM5	OK	Recording
Stop	CAM6	OK	Recording

Other Settings

OSD (All Cameras)

Apply Help

Record Status:

Indicates if the camera is currently recording “Recording” or “Idle” (not recording)

Start All and Start/Stop:

Allows the control of the camera recording state, typically used to temporarily start/stop recording for testing purposes.

OSD:

OSD is the On-Screen Display of data overlay on the video, unchecking this box will the video overlays.

Advanced DVR Settings

Advanced DVR settings are adjusting by clicking on the settings button in the upper right corner of the web page and then selecting the category from the drop-down menu.

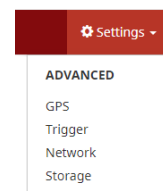

GPS Settings

GPS Status:

Current status of the GPS Signal, if the GPS is not connected or signal has not yet been acquired it will be displayed in this box.

GPS Baudrate:

Baud rate of GPS antenna communication, for the PD-1900 it is 4800. This should only be changed if specified by a PRO-VISION technician.

Speed Unit:

The units used in the on-screen display for the current vehicle speed. (MPH or KPH)

Trigger Settings

This page allows the configuration of all the triggers for activating Alarm functions. Each row in the trigger setup pages refers to a specific trigger.

Triggers 1-3 are the physical trigger wires on the rear of the DVR unit, and Event Marker Button is referring to the external event marker button typically mounted near the driver.

Level/Mode:

Type of signal, set to High if connecting to a 12-24V DC signal or to “Low” if setting to a ground level signal.

Display:

Enter a four-character code to show on the video in the bottom left corner when a trigger is active.
Example: If trigger 1 is for a door sensor, the word DOOR may be used.

Camera Alarm Recording: Select the camera views that will Alarm record when the event has been triggered

Full Screen View:

If selected, when the trigger is active the monitor view will change to the selected view. When the trigger is inactive the view will return to the default view set on the “Display Settings” page.

Alarm Beep:

Checking this box provides an audible tone to alert the operator that a trigger has been activated.

Pre-Event Record Time:

Also known as pre-event recording, this is the amount of time the system will "cache" video for an alarmed event (0-60 seconds). When a trigger is activated, this amount of time before the activation will be added to the start of the event.

Post-Event Record Time:

Also referred to as post-event recording, this is the amount of time an alarm recording will continue after an trigger has been deactivated (0-180 seconds).

Network Settings

The network settings allow the user to configure the LAN and Wi-Fi functions of the DVR unit. The default configuration is to have Wi-Fi enabled using Wi-Fi Access Point Mode. There are two different Wi-Fi modes on the DVR unit that can be set from the “Wi-Fi Mode” option at the top of the page:

1. Access Point Mode:

Enabled by default, this mode allows your smart device to connect directly to the DVR unit for remote configuration and access to view cameras and recorded video files.

2. Client Mode (Unit to Building):

This mode is used to allow your device to automatically connect to your building’s Wi-Fi when it comes into range; this allows the video files on the DVR to be accessed and transferred remotely either manually or automatically using the DVR-928 Automatic File Transfer software.

If you do not want use the built-in Wi-Fi, set the “Wi-Fi” at the top of the page to “Disabled”. Once applied, the only way to connect to the DVR unit is through the LAN connection.

Wi-Fi Settings: Access Point Mode:

Unit IP:

This is the IP address of the DVR unit for communication to your device once connected.

Local SSID:

This is the name of the Wi-Fi AP that the DVR will broadcast, typically it should contain the vehicles unit ID number. The default configuration is to use “PV-HDVR-xxxxxx” where xxxxxx is the last characters of the DVR’s internal MAC address assigned at the factory.

Password:

The password is the security method used to protect the Wi-Fi from undesired access. All DVR units are shipped using a default password of “doesitall” and it is recommended that this is changed to something unique. Typically, the Wi-Fi passwords for all the vehicles in the fleet are set to the same unique password.

Wi-Fi Settings: Client Mode:

Status:

This field displays the current Wi-Fi client connectivity status (Connected/Disconnected).

Unit IP:

If connected, the IP address of the DVR unit will display.

SSID:

This is the name of the Wi-Fi AP on your building that you wish to connect to, ensure that it is typed correctly with capitalization.

Password:

This is the password of the Wi-Fi AP on your building that you wish to connect to, ensure that it is typed correctly with capitalization.

Stored Wi-Fi List:

This displays a list of all available Wi-Fi networks that have been previously entered for the DVR to connect to. If you wish to remove a previous Wi-Fi SSID, select it from the list and press “Remove”.

LAN/AP Settings:

Click “Change LAN/AP Settings” to configure advanced network settings, these settings should only be changed by someone with advanced technical knowledge as they could cause you to lose communication to the DVR.

Primary Internet Gateway:

If the DVR unit is to be connected to the internet, this is the path from the DVR to the internet, unless the LAN cable is connected to a router in a vehicle it should not be changed from the default “Wi-Fi Client” setting.

IP Address:

This is the LAN IP Address of the DVR unit, do not change it unless you are attempting to connect the LAN port of the DVR to another routing device directly.

Netmask:

This is the subnet mask of the DVR unit’s LAN IP.

Reset Values:

This will return the DVR to its original configuration.

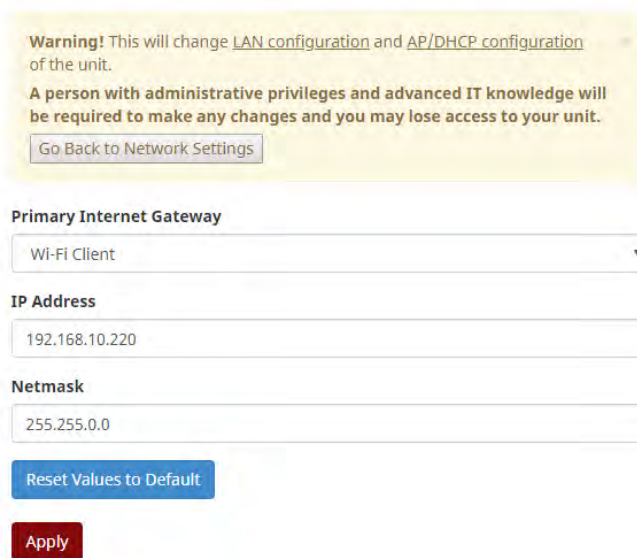

Storage

Disk Information:

This area shows the memory available and free on the SSD or SD card.



Format:

This button will format the disk and erase all previously stored data.

File Explorer:

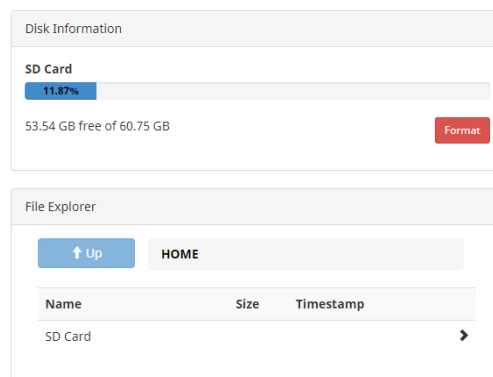
This area allows the user to browse the storage disks and remotely view and download files.



1. Choose the disk (SD or SSD) and click on it to open it.
2. The disk will contain log files that can be viewed or you can choose the “Video” or “Alarm” folder to begin navigating the video file storage.
3. Each file will have two options on the right side:
 - a. Press the “Open” button  to open the file in your web browser (If supported).
 - b. Press the “Download” button  to download the file to your device for local playback.

Stop-Arm Camera

If a DVR-824 Stop-Arm camera is connected to the DVR unit, the “Stop-Arm Camera” settings page will appear in the DVR unit’s web menu under “Advanced” settings.

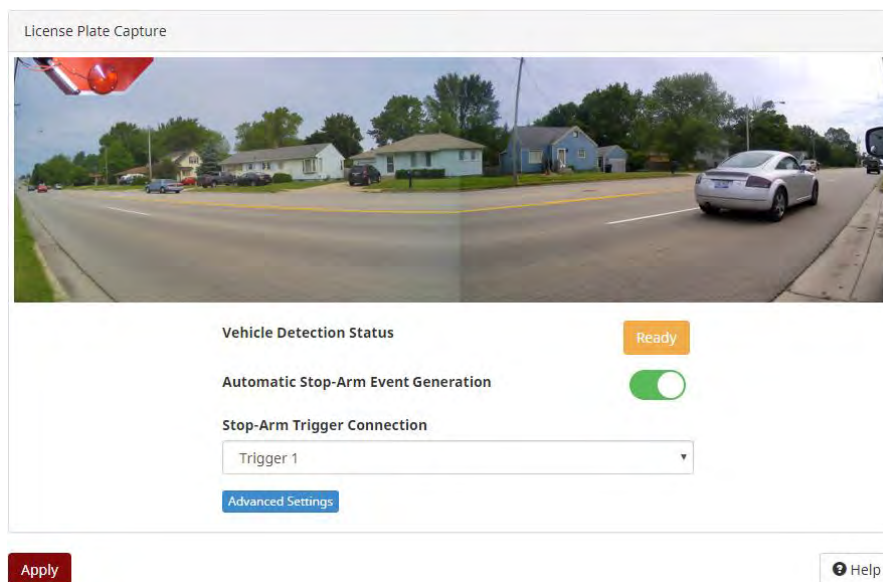

Vehicle Detection Status: Shows the current status of the detection feature.

- Disabled** Feature is disabled
- Ready** Feature is enabled and ready to use
- Detected** Trigger is active and a vehicle or object has passed the stop-arm camera.

Automatic Stop-Arm Event Generation: The switch will enable the automatic event generation. Slide this switch to the right to enable the detection feature.

Stop-Arm Trigger Connection: Select the desired trigger that is connected to the stop-arm open trigger signal. The event detection feature will only be looking for events when this trigger signal is present.

Testing:

To test the stop-arm camera functionality, ensure the page says status of **Ready**, turn on the trigger for the stop-arm by activating the red lights, and then physically move hand across from one camera lens to the other, the status should change to **Detected**.

The DVR unit will create a “Stop-Arm” folder in the root directory of the primary recording disk. Then a folder will be created with the date/time of the event. This folder will contain video files from both cameras for 5 seconds before and 5 seconds after the test event:

- SD/StopArm/20200101/20200101_10/7_201200101_102511_PVVS.avi Rear Facing Camera View
- SD/StopArm/20200101/20200101_10/7_201200101_102511_PVVS.avi Front Facing Camera View

System Info

Unit Info:

Shows the current version of all DVR unit.

Camera Info:

Shows the current versions of each camera and if applicable its model/type.

Import/Update:

Allows configuration files or firmware to be uploaded onto the DVR unit, press “Choose File”, locate your file, then press “Upload” to upload and apply it.

Export Current Configuration:

Exports the current DVR settings to be save into a file that can be reloaded at a later time or loaded on other DVR units.

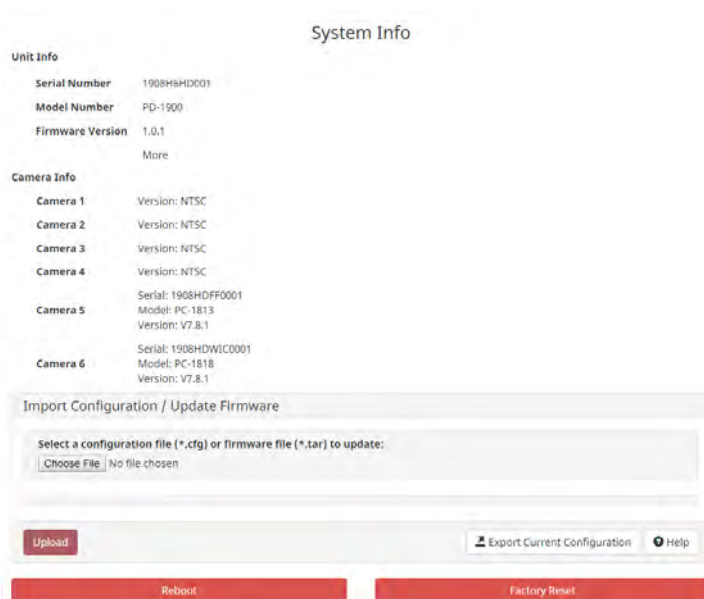

Periodically, PRO-VISION® may offer software updates to add or remove features of the DVR and/or fix minor software bugs. In the event you need a software update to add a function or fix a software issue, a ".tar" file will be sent via email. Simply save the ".tar" file to your computer desktop and using this portion of the DVR Settings Menu, browse for the saved ".tar" file and upload it to the DVR.

The latest firmware can be found at: <http://files.provisionusa.com/firmware/pd1900/PD-1900.html>

Reboot: This action will reboot the DVR to enable any settings that were changed.

Factory Reset: Returns the DVR back to factory default settings.

Vehicle Info

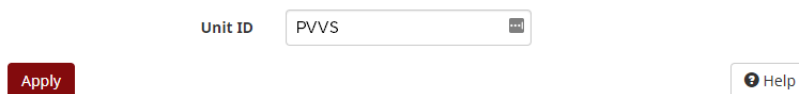

Unit ID: Allows the user to input a unique identifier for the DVR that will show on the video. This aids in establishing which unit video is being viewed. This is typically set to include the department ID as well as the vehicle number, for example: Kent County Sheriff Department unit number 2341 would be set as KCSD2341.

The Unit ID is stamped on the video recording, file names, and in the video file metadata. It is used in searches to find the unit.

DVR Status Lights

A fully functional DVR will display the following status lights while it is actively recording.



- 4G AMBER Normally OFF. Indicates when the DVR is connected to a 4G network. This light requires the DVR to be configured with the optional 4G modem.
- STATUS GREEN/RED Solid green indicates the DVR is on, operating and recording normally. Flashing green indicates the DVR is still booting up, or is operating properly, but is not set to record. Flashing red indicates the system is operating but cannot record; this can be due to a missing or full storage device or DVR issue.
- PWR GREEN Solid green indicates DVR is on. Blinking with green RUN indicates there is no ignition signal and DVR is in the time-delayed shutoff mode.
- RUN GREEN Blinking indicates DVR is on. Blinking with green PWR indicates there is no ignition signal and DVR is in the time-delayed shutoff mode.
- WIFI AMBER Blinking amber indicates the DVR is connected to a Wi-Fi network.
- SYS AMBER Blinking amber indicates the number of cameras configured to record that are not recording, this requires configuration to be accurate.
- SD RED Flashing indicates data is recording to SD card. Solid indicates the SD card is present but no data is being recorded. OFF indicates no SD card is present.
- SSD RED Flashing indicates data is recording to the solid-state drive. Solid indicates solid-state drive is present, but is not recording. OFF indicates there is no solid-state drive present.

Viewing Cameras on a Smart Device

The DVR can be accessed using an Ethernet cable to a laptop or desktop PC, or it can be accessed wirelessly using a laptop, tablet or smartphone device (with Wi-Fi AP Mode enabled).

1. Follow the connections steps in [Connecting to the DVR](#) section of this guide.
2. The “Home” page will open, then choose “Live View” from the top of the page.

“REC” will display in red next to the camera number for cameras that are currently recording.

“ALM REC” will display in yellow next to the camera number for cameras that are currently alarm recording

Select the camera you wish to view by clicking the red camera box; to select multiple cameras click the checkbox(s) next to the red camera box.

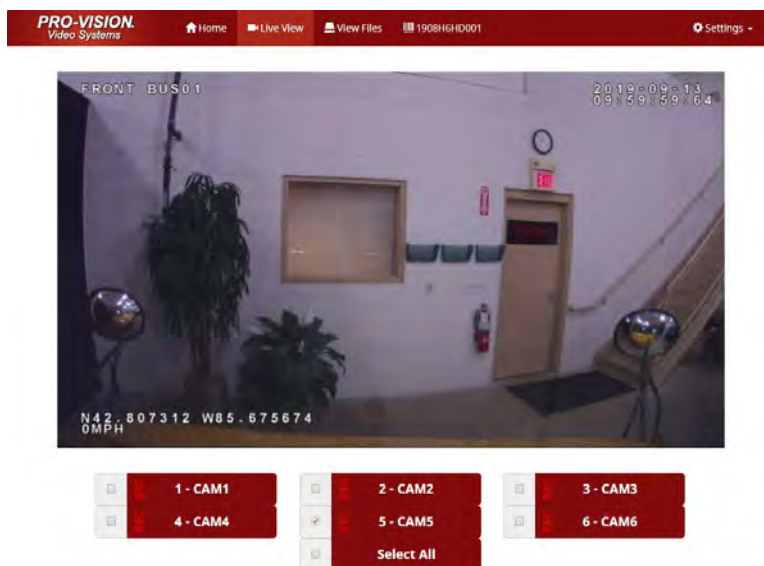

Viewing Cameras on a Display

Cameras can be viewed live on a monitor display. There are two video outputs on the rear of the DVR:

1. **SD A/V Output:**
Using the included A/V Output cable, connect the yellow RCA composite video output to a video input on your display.
2. **HD A/V Output:**
Using a PRO-VISION HD Display Output cable (purchased separately), connect to a VGA port on your display.

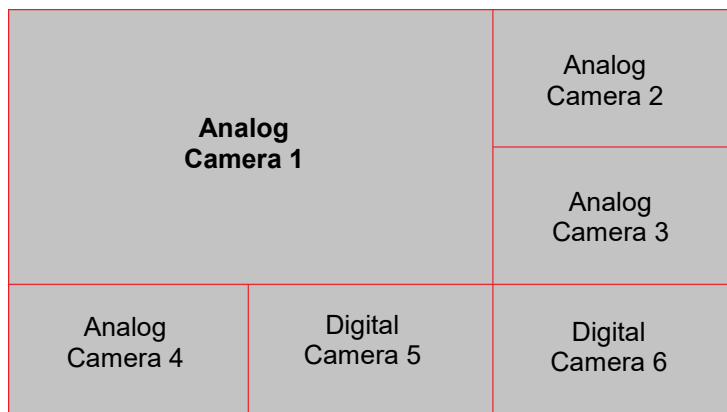



Refer to the connection diagram in the [Installation Quick Guide](#) at the beginning of this document for connection details.

Each of the six cameras will display in a split screen configuration as show above right.

View Files on Web

The DVR can be accessed using an Ethernet cable to a laptop or desktop PC, or it can be accessed wirelessly using a laptop, tablet or smartphone device (with Wi-Fi AP Mode enabled).

4. Follow the connections steps in [Connecting to the DVR](#) section of this guide.
5. The “Home” page will open, then choose “View Files” from the top of the page.
6. Choose the disk (SD or SSD) and then choose the “Video” or “Alarm” folder to begin viewing files.
7. Press the “Open” button  to open the file in your web browser (If supported).
8. Press the “Download” button  to download the file to your device for local playback.

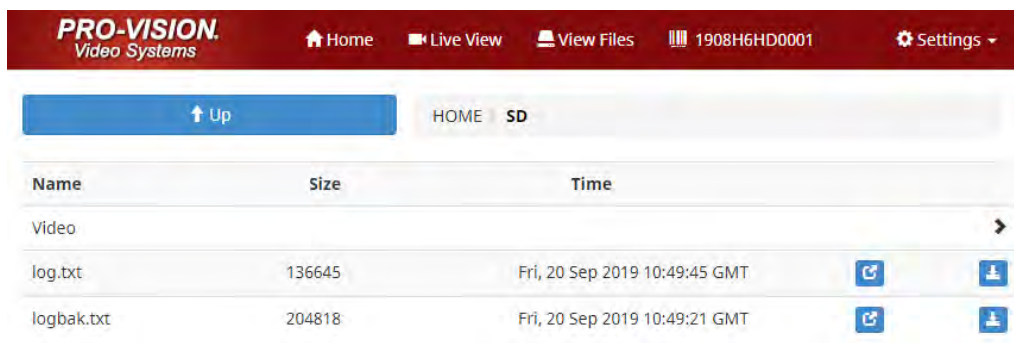

Accessing Stored Video Files

SD Card

If Wi-Fi connection is not possible. The SD Card may be removed from the DVR to transfer/view files

- Press the STOP button on the front of the DVR.
- When the STATUS light on the front of the DVR flashes green, you may remove the SD card.
- Use a DVR-102 SD Card Reader to read the SD card in a laptop or tablet computer.
- Use Windows Explorer to view the Removable Disk folder contents and copy or move files as necessary.

Solid-State Drive

If Wi-Fi connection is not possible. The SSD may be removed from the DVR to transfer/view files.

- Disconnect power to the DVR or press the STOP button on the front of the DVR to put the DVR in standby mode.
- When the STATUS light on the front of the DVR flashes green, you may remove the optional Solid-State Drive (SSD). Note: The DVR will remain in standby mode for 30 seconds. If the STATUS light becomes solid before the SSD has been removed, press STOP again.
- Connect the DVR-802 Solid-State Drive Reader between the SATA connector on the SSD and a USB port on a laptop, desktop or tablet.
- The laptop, desktop or tablet should automatically recognize the SSD as an external disk drive. Due to the large amount of data the SSD holds, it may take several minutes for the SSD to be fully recognized.

See the Video Review Guide on your product disk for advanced playback details including instructions for the PV Player software.

DVR Troubleshooting

Problem	Possible Causes	Solution
DVR has no lights on and will not boot up.	DVR has no battery power or ground signal (no lights on DVR).	Check the fuse(s) on the red battery power and black ground wires on the DVR power cable for proper connection.
DVR has lights on, but will not boot and begin recording.	DVR has no ignition signal.	Check the green ignition wire on the DVR power cable for connection when the vehicle key is ON.
	Ignition signal is set improperly.	DVR's are shipped with a high level (12-24VDC) ignition level setting, if you are using a ground ignition the ignition level must be changed in the interface.
	There is an excessive current draw or power short on a camera, cable or accessory.	Disconnect each item from the DVR one at a time to determine which item was preventing the boot.
The DVR powers on when the key is off and off when the key is on.	Ignition signal is set improperly.	DVR's are shipped with a high level (12-24VDC) ignition level setting, if you are using a ground ignition the ignition level must be changed in the interface.
The DVR remains on after the key is turned off.	The ignition power off delay is set on the DVR.	Adjust the power off delay in the DVR menu to 0 seconds to make it turn off with the ignition.
DVR will not load the SD Card.	The SD card is not inserted fully.	Ensure the SD card is fully inserted and clicked into DVR, it should be flush with the DVR faceplate.
	The SD card is locked in write protected mode.	Remove the card and ensure that the switch on the card is up towards the contacts of the card.
	The SD card is not properly formatted for use in DVR.	Ensure the card is a PRO-VISION SD card and is formatted to the FAT32 file system (Requires IT help).
	SD Card is corrupted.	Reformat the SD card to FAT32, contact tech support if needed.
	SD Card physically damaged.	Contact sales to purchase a replacement.
DVR will not load the Solid-State Drive (SSD).	The SSD card is not full seated in the drive tray.	Ensure the SSD is full inserted and clicked into DVR, it should be flush with the DVR faceplate (screws are recommended but not required).
	The SSD card is not properly formatted for use in DVR.	Ensure the SD card is formatted to the FAT32 file system (Requires IT help).
	SSD Card is corrupted.	Reformat the SSD card to FAT32, contact tech support if needed.
The Status light on the DVR or event button is flashing RED.	The DVR is not recording because it does not have a disk loaded.	See the "DVR is not loading SD card/SSD" section above.
	The DVR is not recording because the SD/SSD is full of video.	Free up space on the disk by enabling Overwrite in the DVR's web interface or by deleting the Alarm video on the disk.
	The DVR is not recording because of a software issue internally.	Contact Tech Support.

DVR is not recording at all.	The SD card or SSD is not able to be loaded by DVR.	See the “DVR is not loading SD card/SSD” section above.
	The camera(s) are not set to record.	Go to the Recording settings page of the web interface and ensure that the recording is set to Auto for each camera.
	There is no free space available on the SD/SSD.	Free up space on the disk by enabling Overwrite in the DVR’s web interface or by deleting the Alarm video on the disk.
DVR is filling up with video and no longer recording (may be beeping also).	If the video on the disk that is full is all in the “Video” folder, then the Overwrite feature is not enabled.	Go to the web interface under Storage and ensure the “Overwrite” box is checked.
	If the video on the disk that is full is all in the “Alarm” folder then something is triggering the recording too often.	Ensure that whatever triggers are set to record are only things that happen on occasion. Triggers that are recording for regular events will always fill up the disk. Check the Triggers, G-Force and GPS pages to uncheck the camera recording boxes for the triggers where recording is not necessary.
DVR is recording some cameras but not all.	The camera(s) that are not recording are not set to record in the menu.	Go to the Recording settings page of the web interface and ensure that the recording is set to Auto for each camera.
	A camera is not working properly or is damaged.	Test to ensure it is a camera problem by swapping that camera to another input on the DVR unit.
	A cable is damaged/broken.	Test the cable by bypassing it with another cable or connecting that camera directly to DVR. Replace if damaged.
	If multiple cables are used, the correct cables might not have been used or were installed improperly.	Ensure that at least one cable is a 30 ft. Repeater cable (has an inline booster) and that the repeater is connected to the DVR. Multiple 20 ft. cables cannot be connected together.
DVR restarts/reboots on its own.	The SD card or SSD is not able to be loaded by DVR.	See the “DVR is not loading SD card/SSD” section above.
	There is a problem with a camera, cable or accessory.	Disconnect each component one at a time to isolate the cause, review the log text file(s) on the SD card to determine what is causing the issue.
	There is a software problem with the DVR unit.	Contact technical support, have the log text file(s) from the SD card available.

SD Card/SSD Troubleshooting

Problem	Possible Causes	Solution
DVR will not load the SD Card or SSD	The SD card or SSD is not inserted fully	Ensure the disk is fully inserted into DVR, it should be flush with the DVR faceplate
	The SD card is locked in write protected mode	Remove the card and ensure that the switch on the card is up towards the contacts of the card
	The SD card or SSD is not properly formatted for use in DVR	Ensure the card is a PRO-VISION disk and is formatted to the FAT32 file system (Requires IT help)
	SD Card or SSD is corrupted	Reformat the disk to FAT32, contact tech support if needed. See below to identify and correct the cause of the corrupted disk
	SD Card or SSD is physically damaged	Contact sales to purchase a replacement
Disk is corrupted or contains abnormal files	Disk was removed from DVR while recording	Ensure that the status light is off or flashing green before removing the disk. If the status light is solid green, press the STOP button on the front of the DVR and wait until the light begins flashing before removing the disk.
	Disk was removed from computer while file was in use	Ensure that all disk folders and playback software is closed before removing the disk from the computer. The best practice is to "Safely Remove" the disk, this will notify you if the disk is currently in use before removing it.
	DVR lost power while recording	If the DVR's battery power or ground wires lose connection while the DVR is in operation, the DVR cannot properly shutdown and files can be corrupted. Allow the DVR to properly shut down or press the "STOP" button and then remove the disk before doing service to the electrical system on the vehicle.
	DVR input voltage dropped below 10V or could not supply enough current to the DVR	If the battery voltage drops below 10V, or the required current can't be provided to the DVR while it is in operation, the DVR cannot properly shutdown and files can be corrupted. This current supply issue can sometimes occur if a major draw on the electrical system occurs such as when the engine's starter is engaged to start the vehicle. Relocating the power connection directly to the battery may resolves this problem. Contact technical support for additional details.
	Computer lost power while disk was in use	Ensure that the disk is properly removed from computer before power is disconnected.
	Disk is damaged	Inspect the disk for physical damage, physical damage to the disk housing may cause the disk to not remain connected properly in the slot during DVR operation causing intermittent loss. Replace the disk with one that is not damaged.
	Disk is malfunctioning	If the disk cannot be formatted, files cannot be erased, or is inaccessible, contact technical support to determine if it can be covered under warranty.

Web/Viewing Troubleshooting

Problem	Possible Causes	Solution
Able to connect to the Wi-Fi but cannot access the DVR web interface.	The device is configured with and incorrect IP.	Ensure that the network settings of the devices Wi-Fi are set to DHCP rather than static IP.
	The web path was entered incorrectly.	Ensure the LAN web address of 192.168.10.254 was entered.
	The DVR's Wi-Fi AP has DHCP disabled.	On your device, enter a static IPv4 address of 192.168.10.100 mask of 255.255.255.0 and then connect to the DVR and go to the Wi-Fi settings and re-enable DHCP.
Can connect to DVR and view web interface but it is not responsive and will not display video.	The DVR is not actually connected and the page you are viewing is an offline stored version from a previous connection.	Establish a connection to the DVR.
Can connect to DVR and view web interface and everything seems to work except live video display.	The browser does not support the VLC® video viewing plugin.	Use a browser that supports the VLC® plugin such as Microsoft® Internet Explorer®.
	The VLC® video plugin is not installed for the browser.	Download VLC® Media Player for your computer from www.videolan.org and install it; plugin for your browser (Microsoft® Internet Explorer®) must be selected during the install.
	The VLC® video plugin has not been activated to allow network access to view video.	Activate the plugin in your browser by going to the Tools > Add-Ons section then find the VLC® Plugin and active it.
The web interface is accessible but some functions do not work properly.	The browser on the device is displaying a stored version of the web page from a previous connection.	Refresh the browser and dump the stored version by pressing Ctrl + F5 while on the DVR web page.
Unable to view recorded videos over Wi-Fi or LAN.	The device does not support video playback or a suitable video player or plugin is not installed.	For laptops, install the VLC® Plugin for Internet Explorer®, for tablets/phones you must download a video playback app from your app store.

DVR Connection/WIFI Troubleshooting

Problem	Possible Causes	Solution
DVR's Wi-Fi is not visible.	DVR is not powered ON or booted up fully.	Ensure the DVR is powered and booted, this takes 30 seconds from the time the key is turned on.
	DVR's Wi-Fi AP is disabled.	Connect a laptop to the DVR's LAN port and enter the DVR web menu to change settings or re-enable the Wi-Fi AP.
	DVR's Wi-Fi AP is set to "Hidden SSID."	Connect a laptop to the DVR's LAN port and enter the DVR web menu to change settings or make the Wi-Fi AP SSID visible.
DVR's Wi-Fi is visible but device does not allow it to connect.	Devices Wi-Fi is disabled.	Re-enable the WIFI on your smartphone, tablet, or computer.
Wi-Fi signal goes in and out.	The signal strength of the Wi-Fi is poor.	Relocate the vehicle, reposition the antennas on the building and/or the vehicle.
	The Wi-Fi is rebooting.	Any time Wi-Fi settings are changed the Wi-Fi must reboot for these changes to take effect.
	The DVR is rebooting.	If the DVR is rebooting, each time it will shut down the Wi-Fi during the reboot.
Wi-Fi light on DVR goes on and then back off.	The Wi-Fi is rebooting.	Any time Wi-Fi settings are changed the Wi-Fi must reboot for these changes to take effect.
	The DVR is rebooting	If the DVR is rebooting, each time it will shut down the Wi-Fi during the reboot.

Able to connect to the Wi-Fi but cannot access the DVR.	The device is configured with and incorrect static IP.	Ensure that the network settings of the devices Wi-Fi are set to DHCP rather than static IP.
	The web path was entered incorrectly.	Ensure the web address of 192.168.10.254 was entered.
	The DVR's Wi-Fi AP has DHCP disabled.	Enter a static IPv4 address of 192.168.10.100 mask of 255.255.255.0 and then connect to the DVR and go to the Wi-Fi settings and re-enable DHCP.
DVR's Wi-Fi Client will not find the buildings Wi-Fi.	The buildings Wi-Fi is out of range of the DVR.	Relocate the vehicle, reposition the antennas on the building and/or the vehicle.
	The buildings Wi-Fi is using an unsupported name format.	Ensure the buildings Wi-Fi SSID name is not using spaces or special characters.
DVR's Wi-Fi Client will not connect the buildings Wi-Fi.	The signal strength is poor of the building's Wi-Fi AP.	Relocate the vehicle, reposition the antennas on the building and/or the vehicle.
	The security key was incorrectly entered.	Find the Wi-Fi AP again and reenter the security key.
	The security mode of the buildings Wi-Fi AP is not compatible with the DVR.	Change the security mode of the buildings Wi-Fi AP.

DVR Status Lights:

LED Light	Indication	Description
STATUS (RED/GREEN LED) - DVR - Event Button	OFF	No power to DVR, or no power to Event Button.
	FLASHING GREEN	DVR is booting up, or is booted up but not set to record.
	ON SOLID GREEN	DVR is recording, DVR is working properly.
	FLASHING RED	DVR cannot record, SD card issue, camera issue.
4G (AMBER LED)	OFF	No power to DVR, no 4G modem, 4G is disabled, or 4G has not yet booted.
	ON SOLID	4G is connected and available for data transfer.
	FLASHING	4G is connected and transferring data to/from DVR.
PWR (GREEN LED)	OFF	No power to DVR.
	ON SOLID	Ignition Accessory Signal Detected and DVR is booting/booted.
	FLASHING	System has no ignition signal and is in a standby/delayed shutoff state.
RUN (GREEN LED)	OFF	No power to DVR.
	ON SOLID	System error state, unplug then reconnect power to reset.
	FLASHING	Delayed shutoff if flashing with PWR, standby if flashing opposite PWR.
Wi-Fi (AMBER LED)	OFF	No power to DVR, Wi-Fi is disabled or not yet booted.
	ON SOLID	Wi-Fi is running and ready for connection(s).
	FLASHING	Wi-Fi is connected and transferring data to/from DVR.
SYS (AMBER LED)	OFF	No power to DVR, system not yet booted.
	ON SOLID	System Processor is running and ready for operation.
	FLASHING	System Processor is in operation.
SD (RED LED)	OFF	No power to DVR, No SD Card Inserted, SD Card is not detected.
	ON SOLID	SD Card has been detected and loaded by DVR.
	FLASHING	SD Card has been loaded and transferring data to/from DVR.
SSD (RED LED)	OFF	No power to DVR, No SSD inserted, SSD is not detected.
	ON SOLID	SSD has been detected and loaded by DVR.
	FLASHING	SSD has been loaded and transferring data to/from DVR.

Camera & Accessory Troubleshooting:

Problem	Possible Causes	Solution
Some cameras are viewable in the web interface but not others.	A camera is disconnected or is not working properly or is damaged.	Test to ensure it is a camera problem by swapping that camera to another input on the DVR unit.
	A cable connection is not connected or the cable is damaged.	Test the cable by bypassing it with another cable or connecting that camera directly to DVR. Replace if damaged.
	If multiple cables are used, the correct cables might not have been used or were installed improperly.	Ensure that at least one cable is a 30 ft. Repeater cable (has an inline booster) and that the repeater is connected to the DVR. Multiple 30 ft. cables cannot be connected together.
No cameras can be viewed live in the web interface.	Connection/Plugin Issue.	See the Web/Viewing section above.
GPS coordinates are not appearing on video files.	The GPS OSD is not enabled on the DVR.	Ensure that the “GPS OSD” is checked in the DVR web interface on the GPS settings page.
GPS speed is not appearing on the video files.	The GPS speed checking is not enabled on the DVR.	Ensure that the “Obtain Speed” box has “From GPS” Selected.
Event Button light is not working.	Event button is not completely connected to DVR cable.	Remove then reinsert the event button connector into the DVR interface cable.
	GPS/EVT/Triggers cable on DVR is not fully connected or is damaged.	Check the cable to ensure that it is fully connected to DVR.
	Event button or cable is damaged.	Contact a sales representative to purchase a replacement.
GPS Overspeed trigger is activating too often.	The speed limit is set to low.	Adjust the “Speed Limit” to a higher speed.
G-Force is activating triggers too often.	The G-Force threshold for the X, Y or Z axis is set to low.	Adjust the threshold for the appropriate axis to a higher G-Force threshold setting.
The trigger wires are activating opposite from when the signal is received.	The signal “Level” is set incorrectly in the DVR interface.	Go to the Triggers page in the DVR menu and adjust the “Level” to the opposite of the current setting.
A beeping noise occasionally is heard on the DVR.	The “Buzzer” is enabled for a connected trigger, G-Force, or GPS.	If desired, set the buzzer setting to “Off” to disable the beeping.
	The DVR has a problem and cannot record.	Check the SD Card, review the log file if necessary.

COMPLIANCE

The PRO-VISION model PD-1900 Hybrid HD Digital Video Recorder (DVR) is a radio transmitter and receiver. It is designed and manufactured not to exceed the emission limits for exposure to radio frequency (RF) energy set by the Federal Communications Commission (FCC) of the U.S. Government. These limits are part of comprehensive guidelines and establish permitted levels of RF energy for the general population. The guidelines are based on standards that were developed by independent scientific organizations through periodic and thorough evaluation of scientific studies. The standards include a substantial safety margin designed to assure the safety of all persons, regardless of age and health. Before a device model is available for sale to the public, it must be tested and certified to the FCC that it does not exceed the limit established by the government-adopted requirement for safe exposure.

This device complies with part 15 of the FCC Rules. Operation is subject to the following two conditions: (1) This device may not cause harmful interference, and (2) this device must accept any interference received, including interference that may cause undesired operation.

This equipment has been tested and found to comply with the limits for a Class B digital device, pursuant to Part 15 of the FCC Rules. These limits are designed to provide reasonable protection against harmful interference in a residential installation. This equipment generates, uses and can radiate radio frequency energy and, if not installed and used in accordance with the instructions, may cause harmful interference to radio communications. However, there is no guarantee that interference will not occur in a particular installation. If this equipment does cause harmful interference to radio or television reception, which can be determined by turning the equipment off and on, the user is encouraged to try to correct the interference by one or more of the following measures:



- Reorient or relocate the receiving antenna.
- Increase the separation between the equipment and receiver.
- Connect the equipment into an outlet on a circuit different from that to which the receiver is connected.
- Consult PRO-VISION Technical Support for help.

Changes or modifications to the equipment not expressly approved by PRO-VISION could void the product warranty and the user's authority to operate the equipment.

WARRANTY

PRO-VISION warranty provisions are applicable to all PRO-VISION DVR-906 system products. See PRO-VISION's website, www.provisionusa.com for detailed warranty information.